

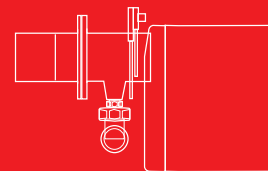

Riello 40 GS Series

One Stage Gas Burners

GS3	11 ÷ 35	kW
GS5	18 ÷ 58	kW
GS10	42 ÷ 116	kW
GS20	81 ÷ 220	kW

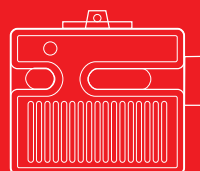

The Riello 40 GS series of one stage gas burners, is a complete range of products developed to respond to any request for home heating. The Riello 40 GS series is available in four different models, with an output ranging from 11 to 220 kW, divided in four different structures.

All the models use the same components designed by Riello for the Riello 40 GS series. The high quality level guarantees safe working. The Riello 40 GS burners are fitted with a microprocessor based control box with diagnostic functions.

In developing these burners, special attention was paid to reducing noise, to the ease of installation and adjustment, to obtaining the smallest size possible to fit into any sort of boiler available on the market.

All the models are approved by the EN 676 European Standard and conform to European Directives for EMC, Low Voltage, Machinery and Boiler Efficiency.

All the Riello 40 GS burners are tested before leaving the factory.

Technical Data

MODEL		GS3	GS5	GS10	GS20	
Burner operation mode		One stage				
Heat output (Hi) (1)	min. - max.	kW kcal/h	11 ÷ 35 9.500 ÷ 30.000	18 ÷ 58 15.500 ÷ 50.000	42 ÷ 116 36.000 ÷ 100.000	81 ÷ 220 70.000 ÷ 189.000
FUEL/AIR DATA						
Fuel		NCV 8 ÷ 12 kWh/m ³ – 7.000 ÷ 10.340 kcal/m ³				
	Family 2 Pressure	min. 5.2 mbar max. 200 mbar	min. 5.9 mbar max. 200 mbar	min. 6.9 mbar max. 360 mbar	min. 6.6 mbar max. 360 mbar	
	Family 3 Pressure	NCV 24 ÷ 34 kWh/m ³ – 21.000 ÷ 29.300 kcal/m ³				
		min. 5.6 mbar max. 200 mbar	min. 7.6 mbar max. 200 mbar	min. 9.7 mbar max. 360 mbar	min. 14.1 mbar max. 360 mbar	
Operation		Intermittent (FS1)				
Use		Boilers: water and diathermic oil				
Ambient temperature	°C	0 - 50				
Combustion air temperature	°C max.	60				
ELECTRICAL DATA						
Electrical supply		1/230V/50Hz				
Fan motor	rpm - rad/s V - Hz W A	2800 - 294 230 - 50 90 0.75		2750 - 288 230 - 50 150 1.3		
Ignition transformer		Primary 230 V Secondary 18 kV / 11 mA		Primary 230 V / 0.2A Secondary 8 kV Primary 230 V / 1.8A Secondary 8 kV / 30mA		
Capacitor	µF	2		5		
Absorbed electrical power	kW	0.15	0.15	0.13	0.25	
Protection level		IP40				
EMISSIONS						
Noise levels (2)	Soundpressure Sound power	dB (A)	53.8 65.0	59.4 70.4	63.1 74.1	66.8 78.5
APPROVAL						
Directive		2006/42/EC - 2016/426/UE - 2014/30/UE - 2014/30/UE				
Conforming to		EN 676 - EN 12100				
Certification		CE-0476CT2714				

Reference conditions:

(1) Temperature: 20°C - Pressure: 1013.5 mbar - Altitude: 0 m a.s.l. - Noise measured at a distance of 1 meter.

(2) Sound pressure measured in manufacturer's combustion laboratory, with burner operating on test boiler and at maximum rated output. The sound power is measured with the "Free Field" method, as per EN 15036, and according to an "Accuracy: Category 3" measuring accuracy, as set out in EN ISO 3746.

Firing Rates

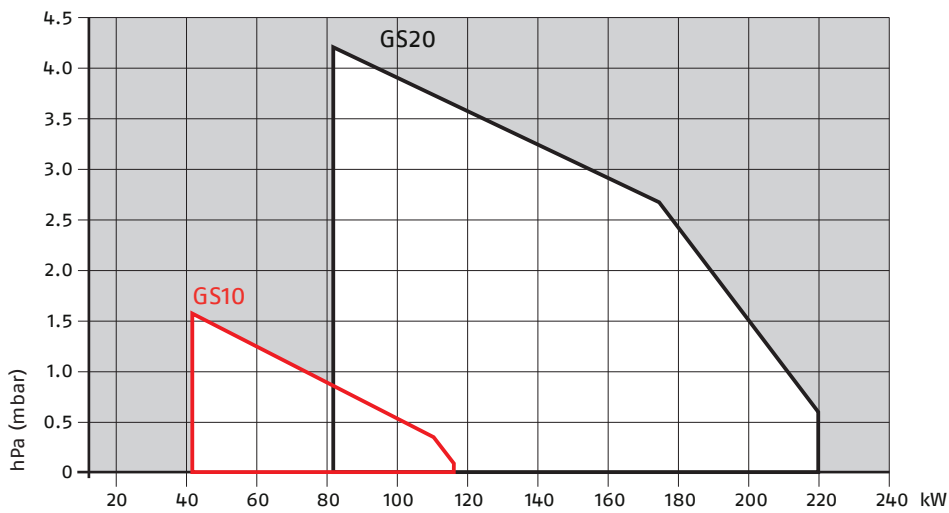
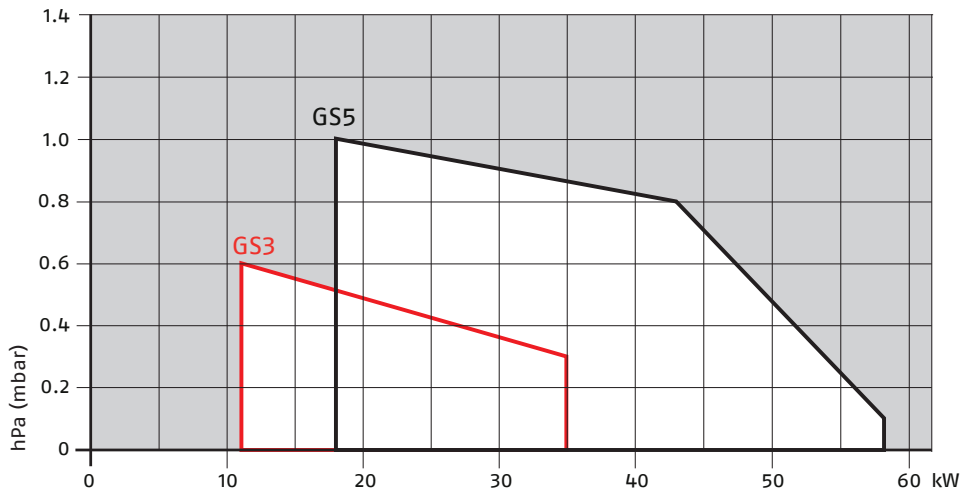

Useful working field for choosing the burner

Test conditions conforming to EN 676:
 Temperature: 20°C
 Pressure: 1013,5 mbar
 Altitude: 0 m a.s.l.

Gas train

GAS TRAIN DESIGNATION

Series: MB
 MBC
 VGD
 CB
 DMV
 CG

Size:	405	407	410	412	415	420	-
	65	1200	1900	3100	5000		
	50	65	80	100	-	-	-
	512	520	525	5065	5080	50100	50125
	120	220	-	-	-	-	-

Operation: /S only ON-OFF function
 /1 stage mode opening
 /2 2nd stage mode opening
 /P 1st stage mode opening with air/gas proportional regulator

Leak detection control: - 0
 CT leak detection control device installed on the gas train
 CQ equipped with pressure switch for leak detection control

Joint type: R threaded joint
 F standard flange ISO
 F1 square flange BS1
 F2 square flange BS2
 F3 square flange BS3 - BS4

Electrical connection: T Terminals - Terminal strip
 SD Domestic plug
 SM Medium voltage plug

Standard output pressure range:

-	without pressure governor
0	with governor and air/gas proportional pressure
2	with governor and output pressure up to 20 mbar
3	with governor and output pressure up to 30 mbar
4	with governor and output pressure up to 40 mbar
5	with governor and output pressure up to 50 mbar
6	with governor and output pressure up to 60 mbar
8	with governor and output pressure up to 80 mbar
15	with governor and output pressure up to 150 mbar

Valve control: 0 shared
 2 separate

CB	5065	/1	CT	F	SM	3	0
BASIC DESIGNATION				EXTENDED DESIGNATION			

GAS TRAINS

The burners are set for gas supply from either the right or left hand sides. Depending on the fuel output and the available pressure in the supply line, you should check the correct gas train to be adapted to the system requirements. The gas train is Multibloc type, containing the main components in a single unit and it can be fitted with the valves seal control (as accessory).

MBC 65/1

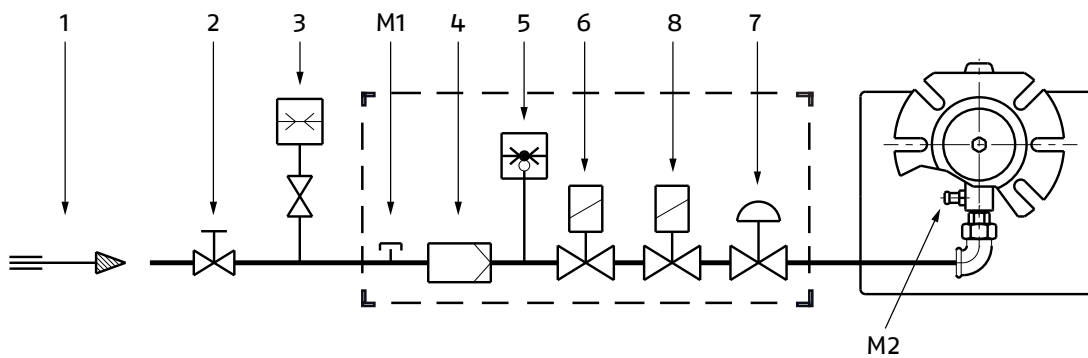

MBC 405-407/1

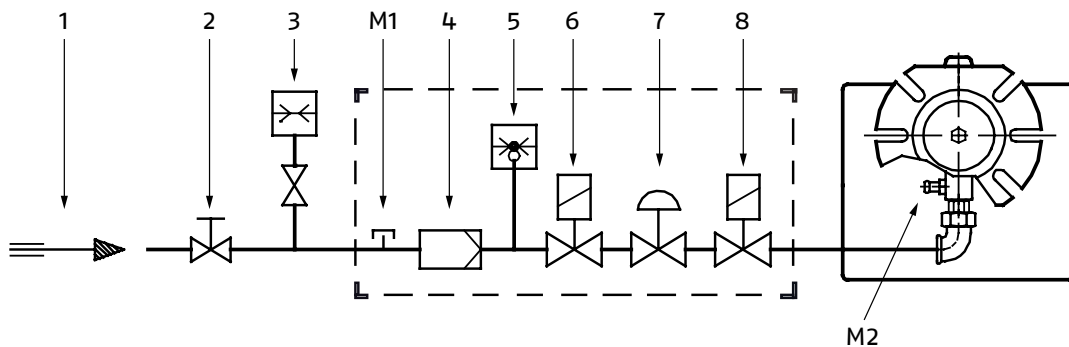

MBC 410/1

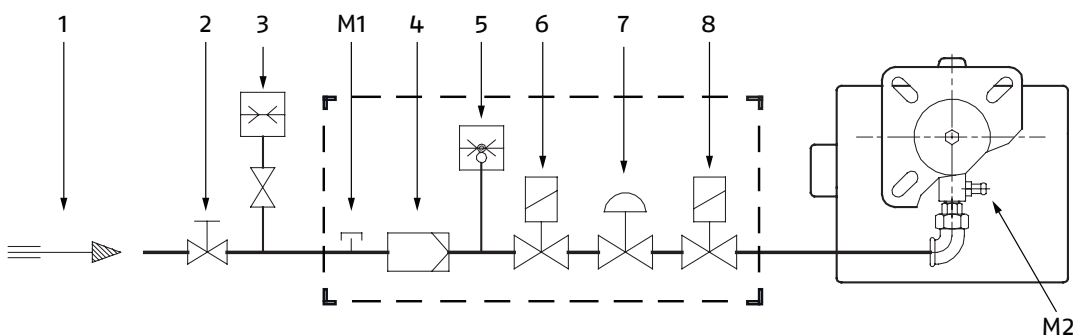

1	Gas input pipe
2	Manual gate (the responsibility of the installer)
3	Gas pressure gauge (the responsibility of the installer)
4	Filter
5	Gas pressure switch
6	Safety valve
7	Pressure stabiliser
8	Adjustment valve
M1	Gas-supply pressure test point on the pressure switch
M2	Pressure coupling test point

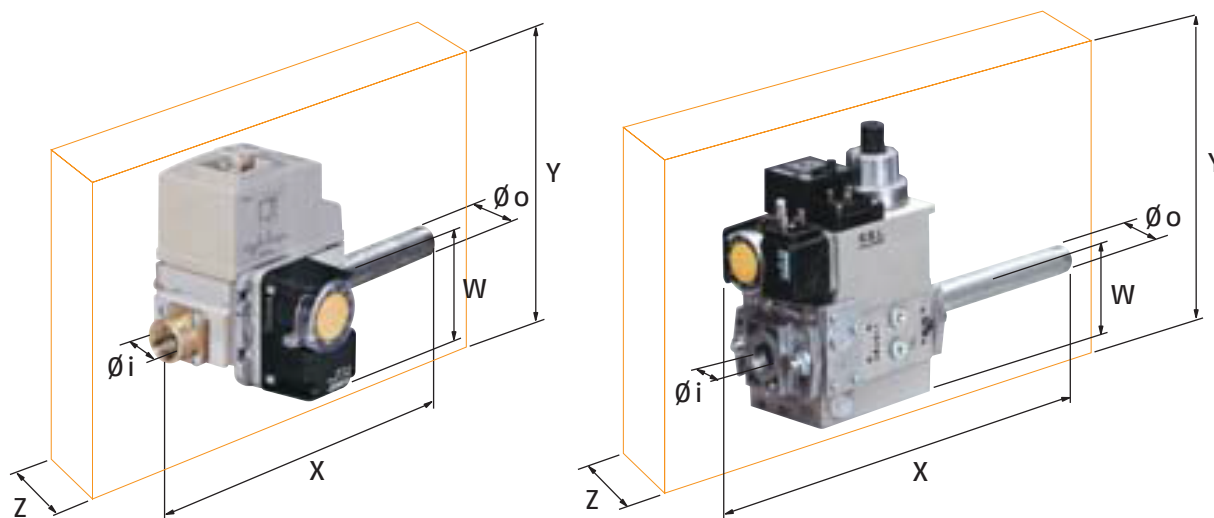

The dimensions of the gas trains vary depending on their construction features. The following table shows the dimensions of the gas trains that can be fitted to Riello 40 GS burners, intake and outlet diameters.

GAS TRAIN								BURNER		NOTE
MODEL	CODE *	Ø in	Ø out	X mm	Y mm	W mm	Z mm	NATURAL GAS	LPG	
MBC 65/1	3970569	Rp 1/2"	Rp 1/2"	307	155	31	122	GS3 - GS5 GS10	GS3 - GS5 GS10	(1)
MB 405/1	3970530	Rp 1/2"	Rp 1/2"	321	186	46	120	GS3 - GS5 GS10	GS3 - GS5 GS10	(1) (4)
MB 407/1	3970531	Rp 3/4"	Rp 3/4"	371	186	46	120	GS3 - GS5 GS10 - GS20	GS10 - GS20	(1) (3)
MB 410/1	3970532	Rp 1"	Rp 3/4"	405	221	55	145	GS5 - GS10 - GS20	GS10 - GS20	(1)

Please see Designation of Gas Train Series in the page before the Catalogue index.

* Gas train are 230V/50Hz - 220V/60Hz electrical supply

(1) With installed plug (if the plug is not necessary, remove it in accordance with gas train instruction manual indication)

(2) GS10 ≤ 80 kW with natural gas

(3) GS20 ≤ 180 kW with natural gas

(4) With 1/2" - 3/4" reduction nipple supplied

The valve seal control device is compulsory (conforming to EN 676) on gas trains to burners with a maximum output over 1200 kW.

To select the gas train please refer to the technical data leaflet and/or instruction manual.

Pressure Drop Diagram

The diagrams indicate the minimum pressure drop of the burners with the various gas trains that can be matched with them; at the value of these pressure drop add the combustion chamber pressure. The value thus calculated represents the minimum required input pressure to the gas train.

GS3 (NATURAL GAS)

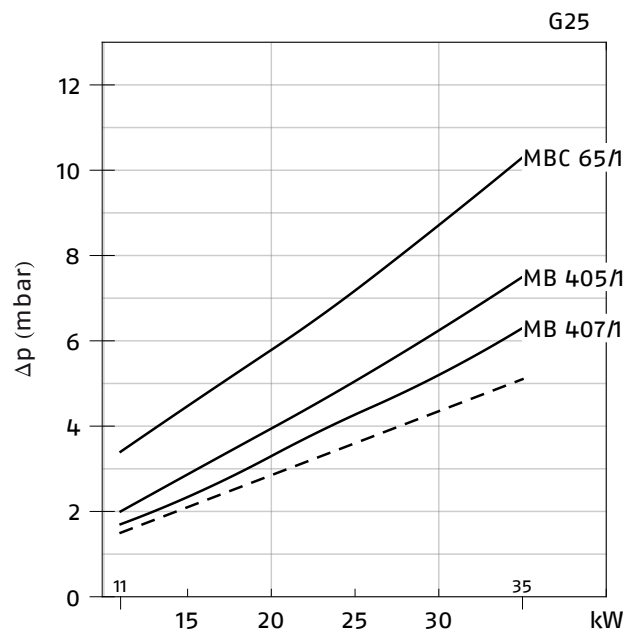
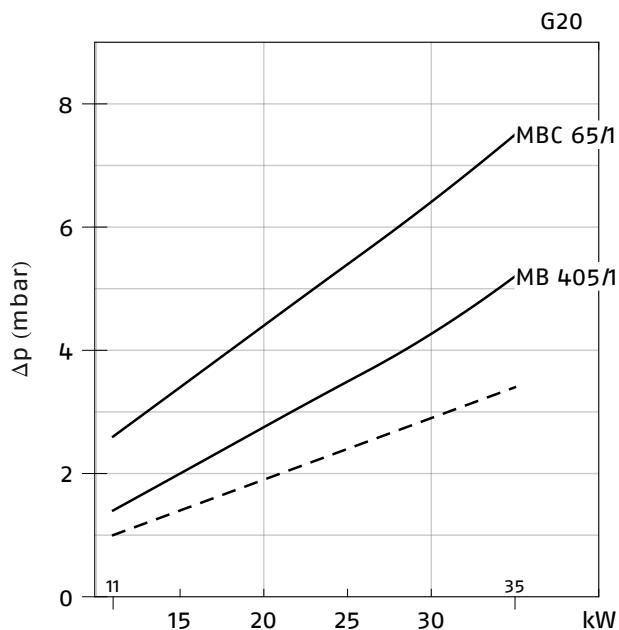

GS3 (LPG)

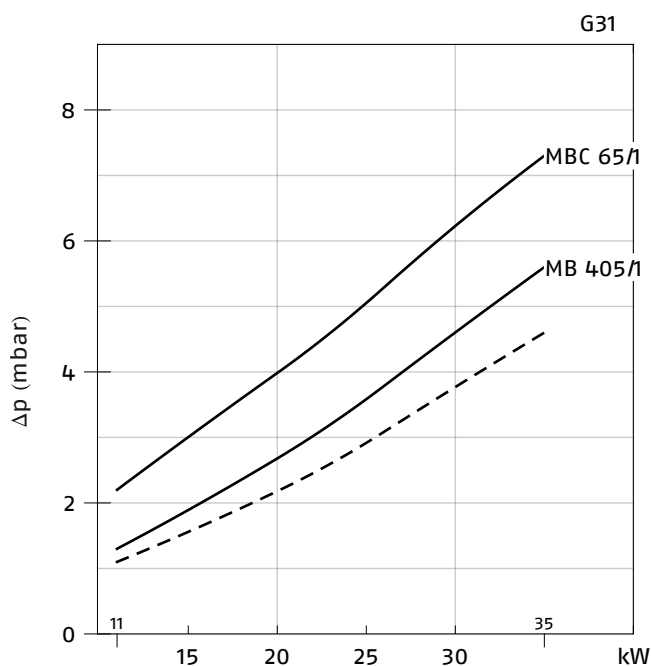

For pressure levels different from those indicated above, please contact Riello Burners Technical Office.
 In LPG plants, Multibloc gas trains do not operate below 0°C.
 They are only suitable for gaseous LPG (liquid hydrocarbons destroy the seal materials).

- Combustion head + gas train
- - - Combustion head

GS5 (NATURAL GAS)

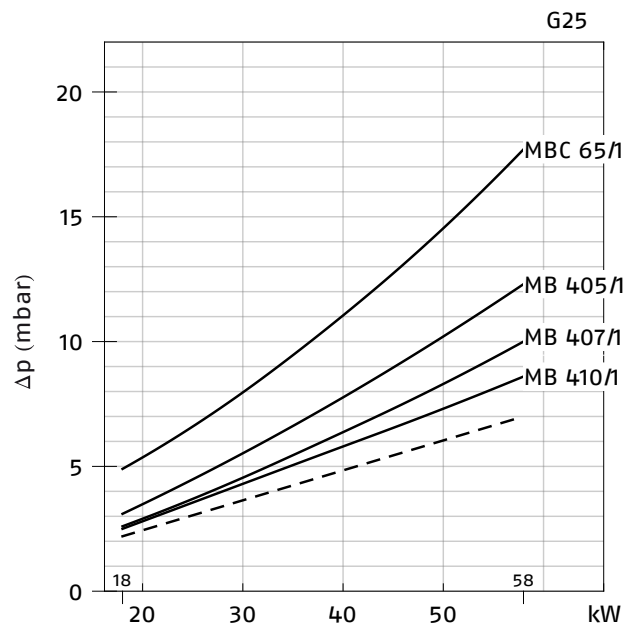
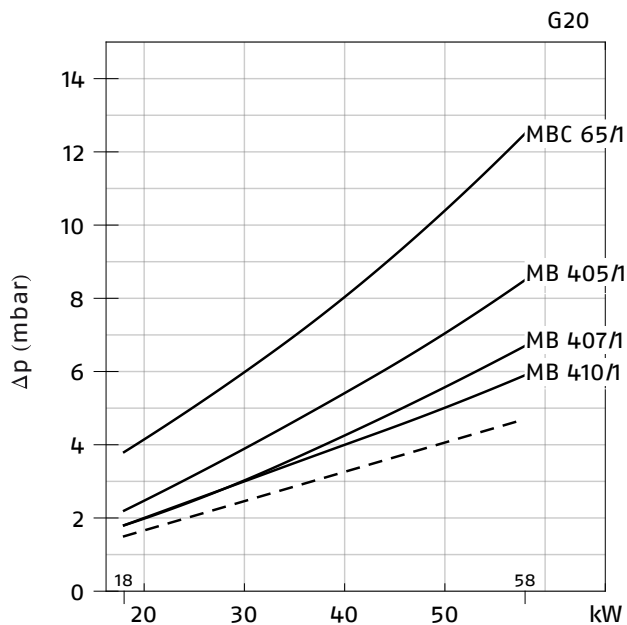

GS5 (LPG)

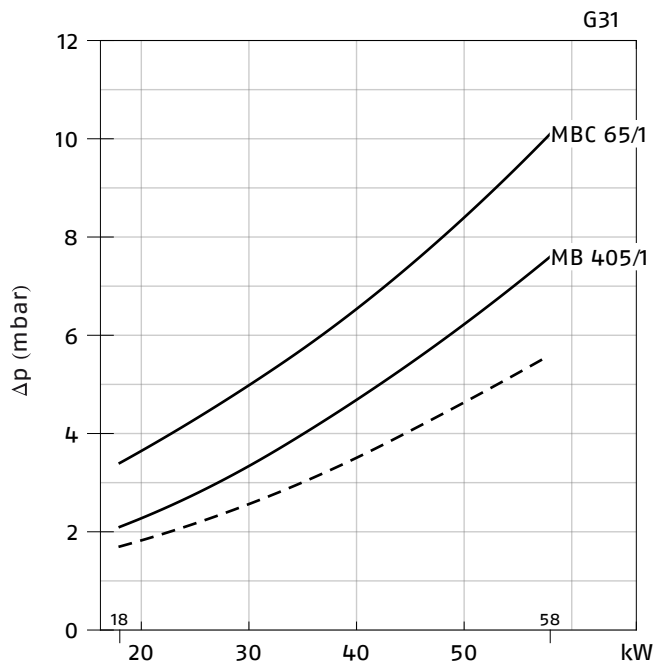

For pressure levels different from those indicated above, please contact Riello Burners Technical Office.
 In LPG plants, Multibloc gas trains do not operate below 0°C.
 They are only suitable for gaseous LPG (liquid hydrocarbons destroy the seal materials).

- Combustion head + gas train
- - - Combustion head

GS10 (NATURAL GAS)

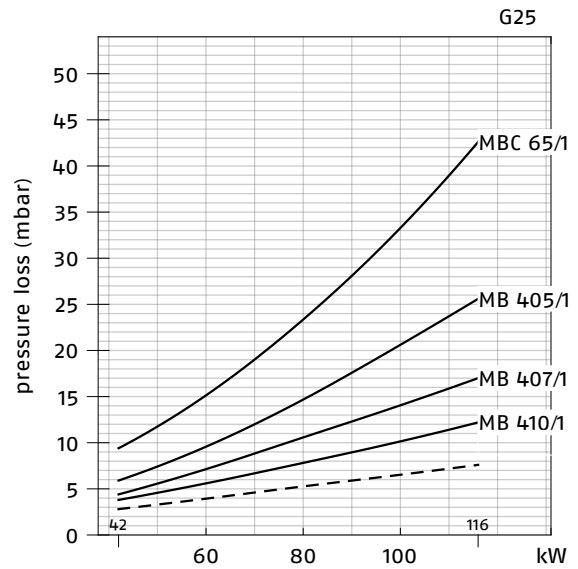
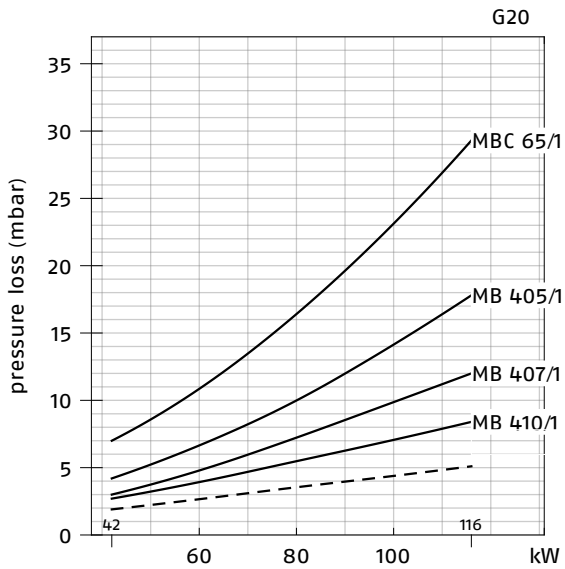

GS10 (LPG)

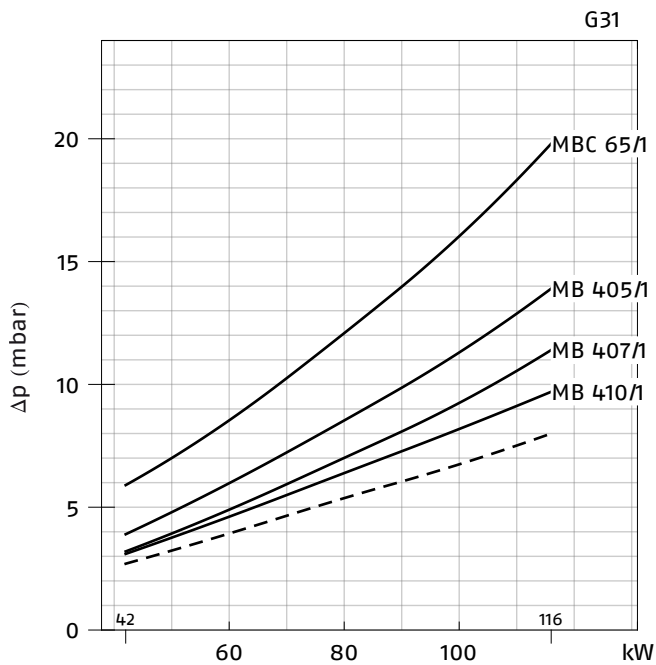

For pressure levels different from those indicated above, please contact Riello Burners Technical Office.

In LPG plants, Multibloc gas trains do not operate below 0°C.

They are only suitable for gaseous LPG (liquid hydrocarbons destroy the seal materials).

- Combustion head + gas train
- - - Combustion head

GS20 (NATURAL GAS)

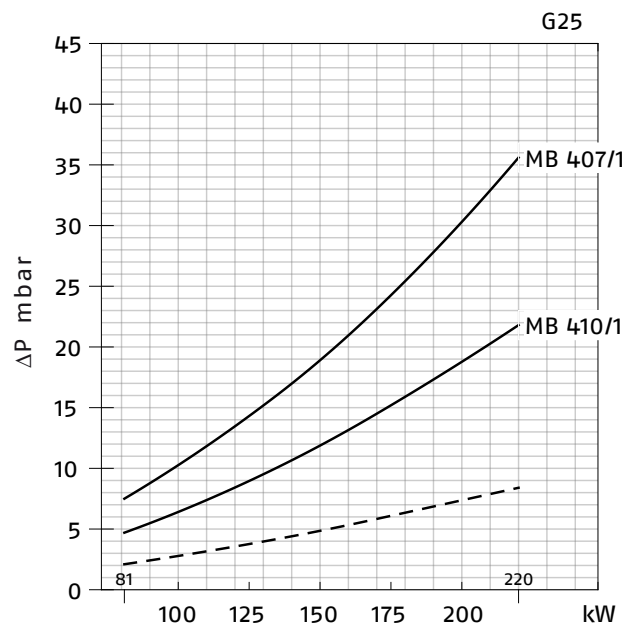
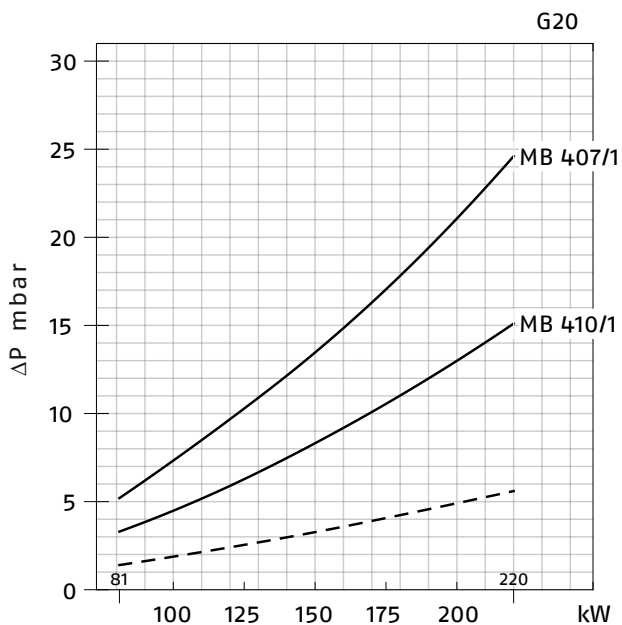

GS20 (LPG)

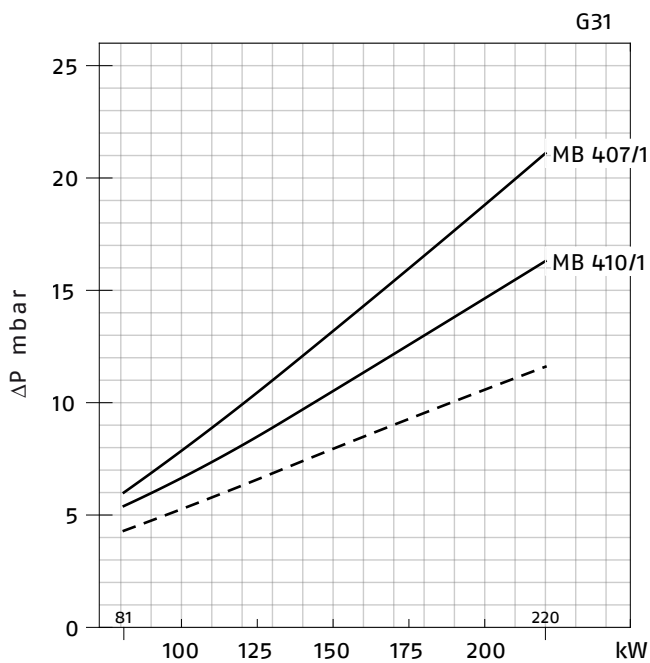

For pressure levels different from those indicated above, please contact Riello Burners Technical Office.

In LPG plants, Multibloc gas trains do not operate below 0°C.

They are only suitable for gaseous LPG (liquid hydrocarbons destroy the seal materials).

- Combustion head + gas train
- - - Combustion head

Ventilation

The different ventilation circuits always ensure low noise levels with high performance of pressure and air delivery, inspite of their compact size. The burners are fitted with an adjustable air pressure switch, conforming to EN 676 standards.



Air suction

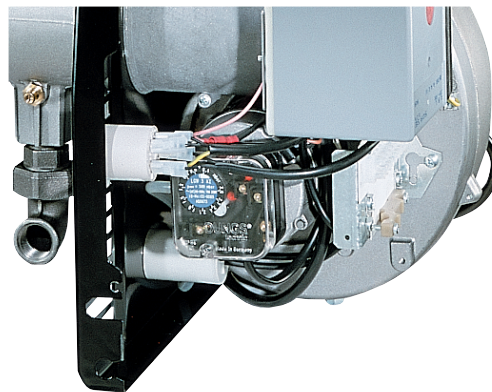

Air pressure switches

Combustion Head

The combustion head in Riello 40 GS burners is the result of an innovative design, which allows combustion with low polluting emissions, while being easy to adapt to all the various types of boilers and combustion chambers.



Combustion head

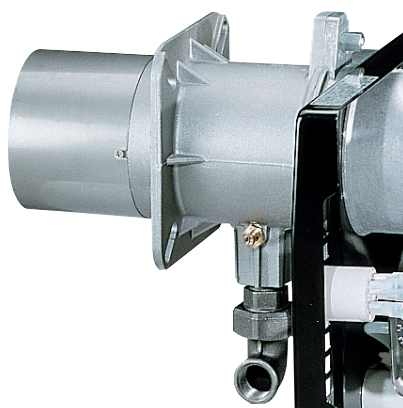

Mobile flange

Simple adjustment allows the internal geometry of the combustion head to be adapted to the burner output.

DIMENSIONS OF THE FLAME

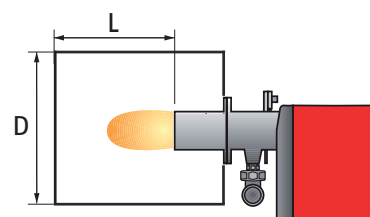
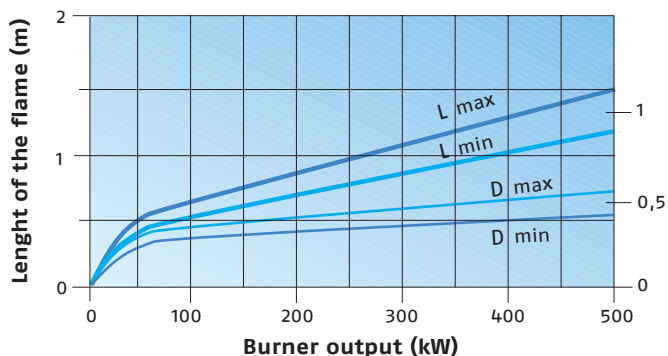

Example:
 Burner thermal output = 350 kW;
 L flame (m) = 1.2 m (medium value);
 D flame (m) = 0.6 m (medium value)

Operation

BURNER OPERATION MODE

All these models are one stage operation.

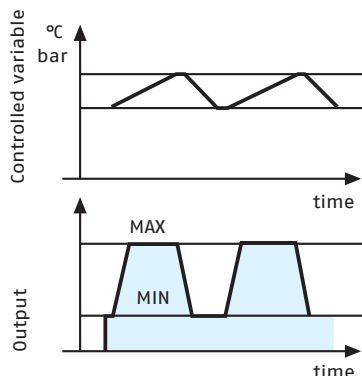

One stage operation

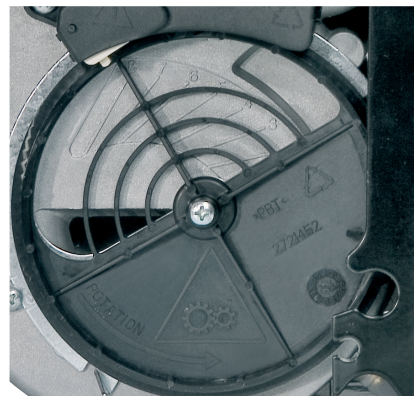

Air damper partially open (GS3, GS5)

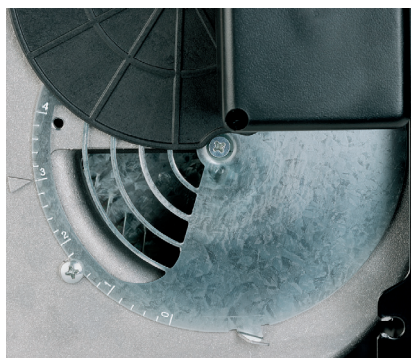

Air damper partially open (GS10, GS20)

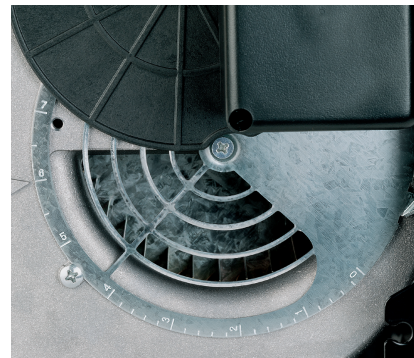

Air damper completely open (GS10, GS20)

The GS3 and GS5 models are fitted with the new microprocessor control panel. For helping the commissioning and maintenance work, there are two main elements:



The lock-out reset button is the central **operating element** for resetting the burner control and for activating / deactivating the diagnostic functions.



The multi-color LED is the central **indication element** for visual diagnosis and interface diagnosis.

Both elements are located under the transparent cover of lock-out reset button, as showed below.

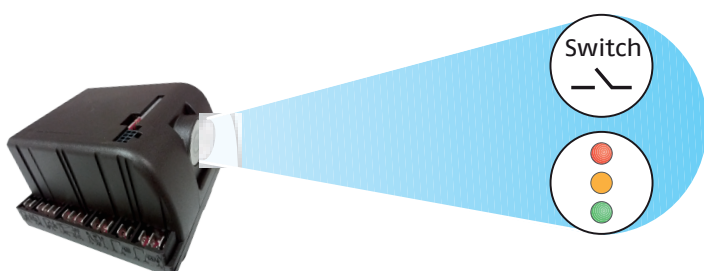

There are two diagnostic choices, for indication of operation and diagnosis of fault cause:

- visual diagnosis:

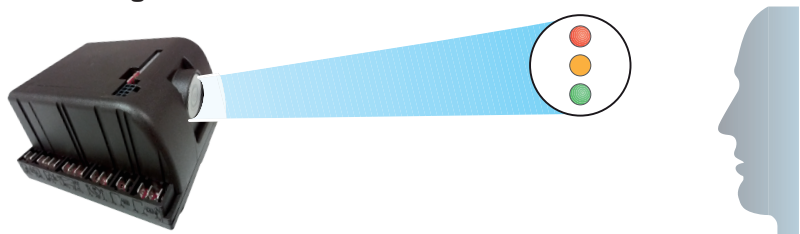

- interface diagnosis:

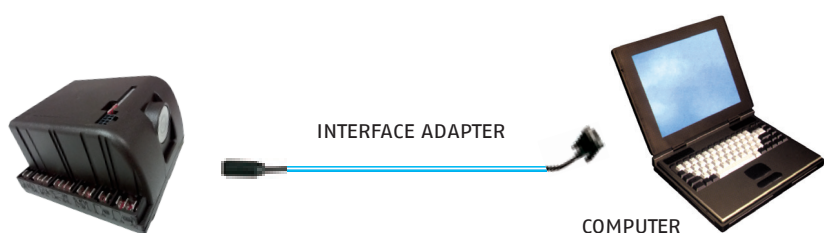

By the interface adapter and a PC with dedicated software.

Indication of operation:

In normal operation, the various statues are indicated in the form of colour codes according to the table below.





Color code table

Operation status	Color code	Color
Stand-by	○ ○ ○ ○ ○ ○ ○ ○	Off
Pre-purging	☀ ○ ☀ ○ ☀ ○ ☀ ○	Flashing orange
Ignition phase	☀ ○ ☀ ○ ☀ ○ ☀ ○	Flashing green
Flame OK	☀ ☀ ☀ ☀ ☀ ☀ ☀ ☀	Green
Undervoltage/overvoltage	☀ ☀ ○ ○ ☀ ☀ ○ ○	Low flashing orange
Fault, alarm	☀ ☀ ☀ ☀ ☀ ☀ ☀ ☀	Red
Extraneous light	☀ ☀ ☀ ☀ ☀ ☀ ☀ ☀	Green - Red

Diagnosis of fault causes:

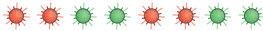
After lock-out has occurred, the red signal lamp is steady on. In this status, the visual fault diagnosis is in according to the error code table below:

Error code table

Signal	Possible cause
<p>Red</p> 	<p>The flame does not stabilise at the end of the safety time:</p> <ul style="list-style-type: none"> - faulty ionisation probe - faulty or soiled gas valves - neutral/phase exchange - faulty ignition transformer - poor burner regulation (insufficient gas)
<p>Red - green</p> 	<p>Min. air pressure switch does not close after the limit thermostat closed:</p> <ul style="list-style-type: none"> - air pressure switch faulty - air pressure switch incorrectly regulated
<p>Flashing red</p> 	<p>Presence of flame:</p> <ul style="list-style-type: none"> - in stand-by position after heat demand - during pre-purging
<p>Slow flashing red</p> 	<p>Loss air pressure:</p> <ul style="list-style-type: none"> - during pre-purging - during safety time or operations
<p>Fast flashing red</p> 	<p>Loss of flame 4 times during operations after 3 attempts of re-cycle:</p> <ul style="list-style-type: none"> - poor burner regulation (insufficient gas) - faulty or soiled gas valves - short circuit between ionisation probe and earth - faulty ionisation probe
<p>Red - orange</p> 	<p>Min. air pressure switch is already closed before the limit thermostat closed:</p> <ul style="list-style-type: none"> - air pressure switch faulty - air pressure switch incorrectly regulated

The GS10 and GS20 models are fitted with the new microprocessor control panel for the supervision during intermittent operation.

For helping the commissioning and maintenance work, there are two main elements:



The lock-out reset button is the central operating element for resetting the burner control and for activating / deactivating the diagnostic functions.



The multi-color LED is the central indication element for visual diagnosis and interface diagnosis.

Both elements are located under the transparent cover of lock-out reset button, as showed below.

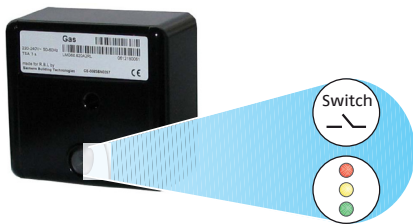

There are two diagnostic choices, for indication of operation and diagnosis of fault cause:

- visual diagnosis:

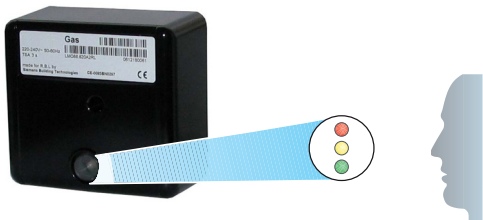

- interface diagnosis:

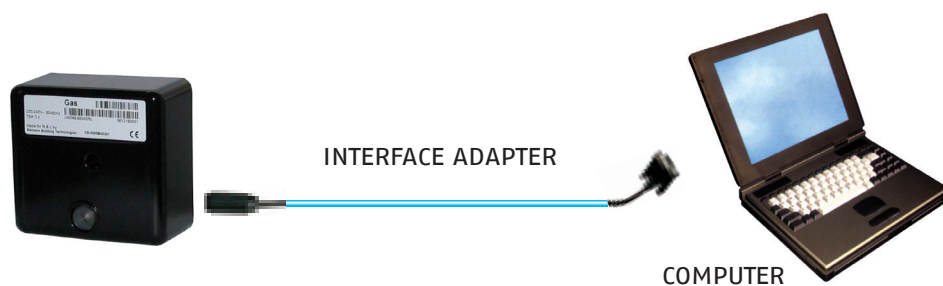

By the interface adapter and a PC with dedicated software.

Indication of operation:

In normal operation, the various status are indicated in the form of colour codes according to the table below. The interface diagnosis (with adapter) can be activated by pressing the lock-out button for > 3 seconds.

Color code table		
Operation status	Color code	Color
Stand-by	○ ○ ○ ○ ○ ○ ○ ○	Off
Pre-purging	☀ ☀ ☀ ☀ ☀ ☀ ☀ ☀	Yellow
Ignition phase	☀ ○ ☀ ○ ☀ ○ ☀ ○	Flashing yellow
Flame OK	☘ ☘ ☘ ☘ ☘ ☘ ☘ ☘	Green
Poor flame	☘ ○ ☘ ○ ☘ ○ ☘ ○	Flashing green
Undervoltage/overvoltage	☀ ☘ ☀ ☘ ☀ ☘ ☀ ☘	Yellow red
Fault, alarm	☘ ☘ ☘ ☘ ☘ ☘ ☘ ☘	Red
Extraneous light	☘ ☘ ☘ ☘ ☘ ☘ ☘ ☘	Green - Red

Diagnosis of fault causes:

After lock-out has occurred, the red signal lamp is steady on. In this status, the visual fault diagnosis according to the error code table can be activated by pressing the lock-out reset button for > 3 seconds. The interface diagnosis (with adapter) can be activated by pressing again the lock-out button for > 3 seconds. The flashes of red LED are a signal with this sequence :

(e.g. signal with n° 3 flashes – faulty air pressure monitor)

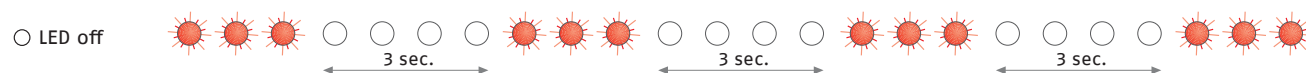

Error code table

Flash code	Possible cause of fault
2 flashes ☘ ☘	No establishment of flame at the end of safety time : - faulty or soiled fuel valves - faulty or soiled flame detector - poor adjustment of burner, no fuel - faulty ignition equipment
3 flashes ☘ ☘ ☘	Faulty air pressure switch
4 flashes ☘ ☘ ☘ ☘	Simulation of flame on burner start up
7 flashes ☘ ☘ ☘ ☘ ☘ ☘ ☘	Loss of flame during operation : - faulty or soiled fuel valves - faulty or soiled flame detector - poor adjustment of burner
10 flashes ☘ ☘ ☘ ☘ ☘ ☘ ☘ ☘ ☘ ☘	Wiring error or internal fault

START UP CYCLE GS3-5

Normal operation

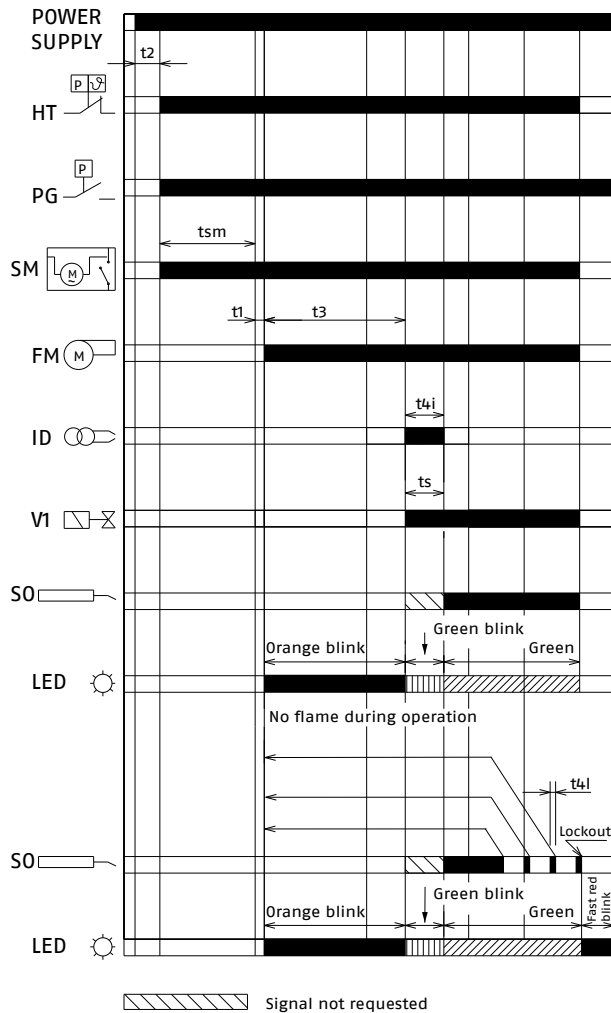

Lockout due to extraneous light during pre-purging

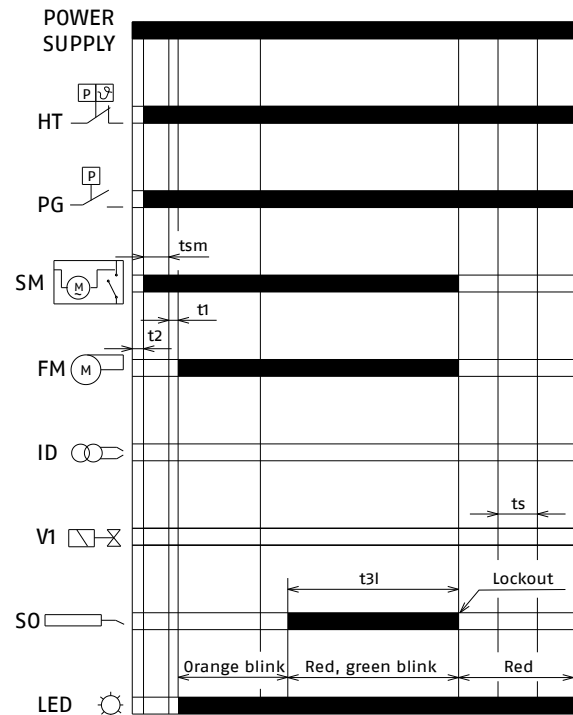

KEY

FM	Fan motor
HT	Heat request
ID	Ignition device
LED	LED colour inside the button
PG	Low gas pressure switch
SM	Electric servomotor damper opener
S0	Ionisation probe
t_{sm}	Standby time for servomotor opening of the electric damper opener
t_1	Standby time
t_2	Initialisation time for checking
t_3	Pre-purging time
t_{3l}	Checks for presence of extraneous light during pre-purging phase
t_{4i}	Total ignition time
t_{4l}	Reaction time to achieve safety lockout due to lack of failure
t_s	Safety time
V1	Gas valve

Lockout due to ignition failure

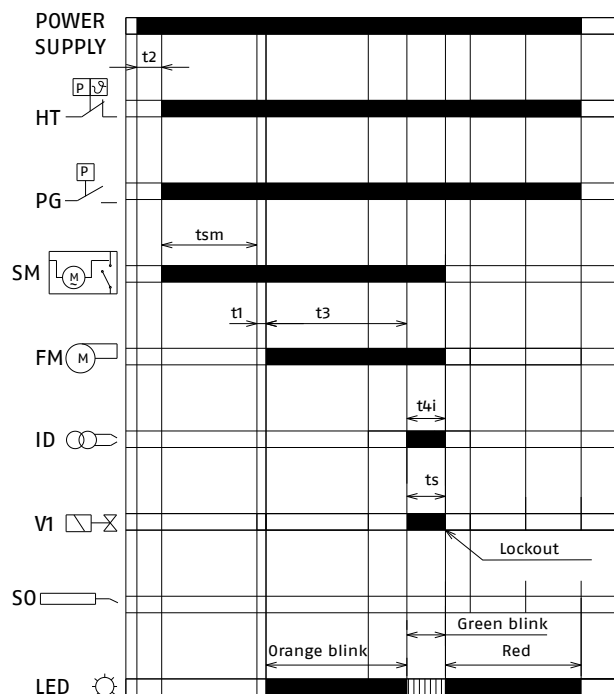

KEY	
FM	Fan motor
HT	Heat request
ID	Ignition device
LED	LED colour inside the button
PG	Low gas pressure switch
SM	Electric servomotor damper opener
S0	Ionisation probe
t _{sm}	Standby time for servomotor opening of the electric damper opener
t ₁	Standby time
t ₂	Initialisation time for checking
t ₃	Pre-purging time
t _{3l}	Checks for presence of extraneous light during pre-purging phase
t _{4i}	Total ignition time
t _{4l}	Reaction time to achieve safety lockout due to lack of failure
t _s	Safety time
V1	Gas valve

Operating times (seconds)

t ₁	t ₂	t ₃	t _{3l} , t _{4l}	t _{4i}	t _s	t _{sm}
max	max	-	max	-	-	-
2	4.5	40	1	3	3	4

START UP CYCLE GS10-20

Operation sequence of the burner

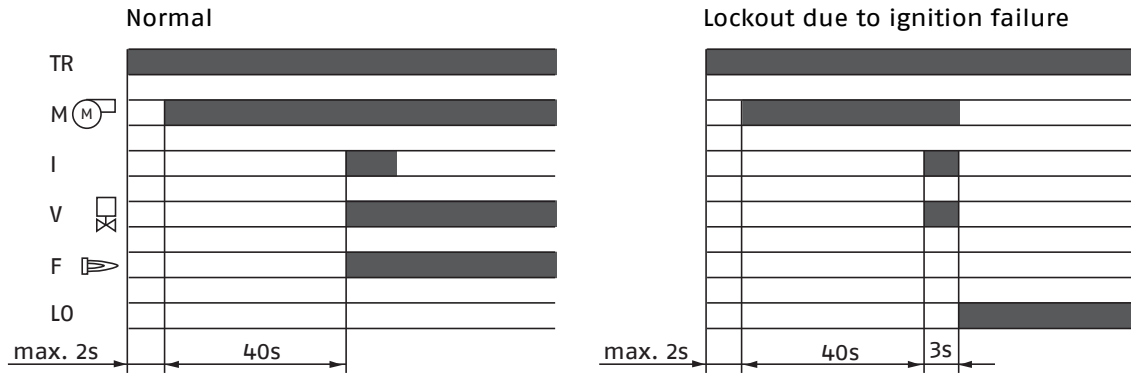

KEY

F	Flame
F2	2nd stage flame
L0	Lockout
M	Fan motor
TL	Limit thermostat
V	Valves

Lock-out due to ignition failure

If the flame goes out while running, the burner goes into lockout within one second.

Emissions

The emission data have been measured in the various models at maximum output, in conformity with EN 676 standard.

NOx EMISSIONS

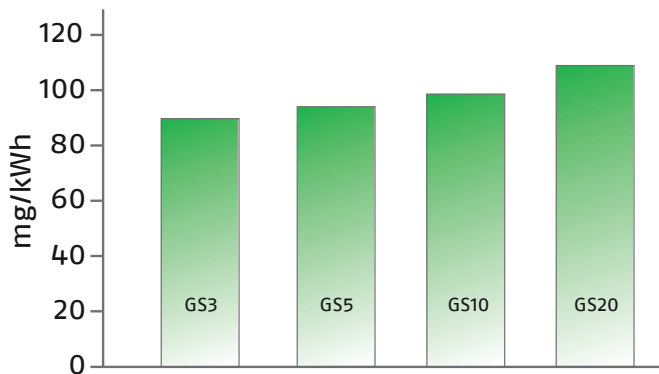

CO EMISSIONS

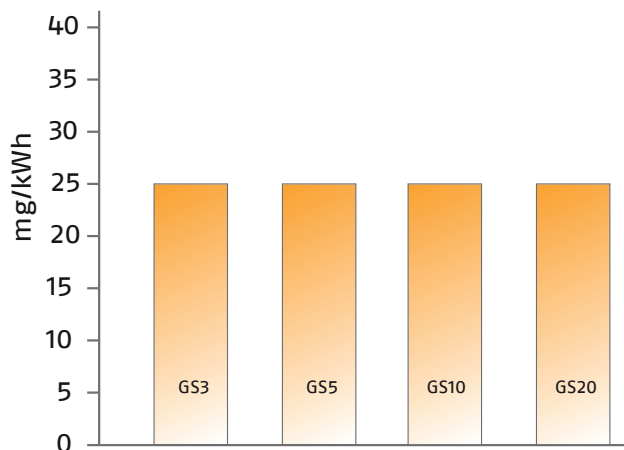

NOISE EMISSIONS

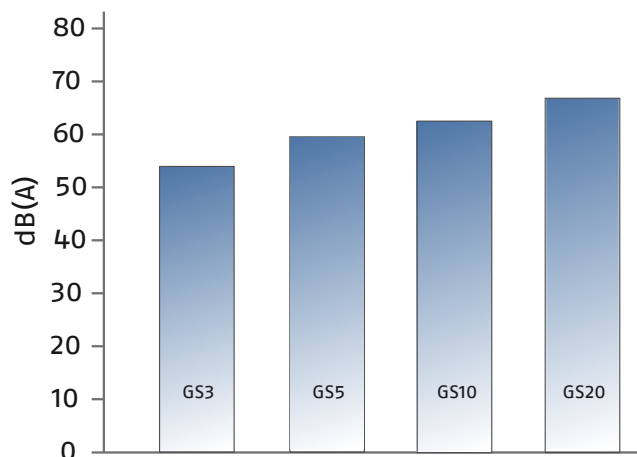

Special attention has been paid to noise reduction. All models are fitted with sound-proofing material inside the cover.



Overall Dimensions (mm)

These models are distinguished by their reduced size, in relation to the outputs achieved, which means they can be fitted to any boiler on the market.

BURNER

GS3 - GS5 - GS10*** - GS20***

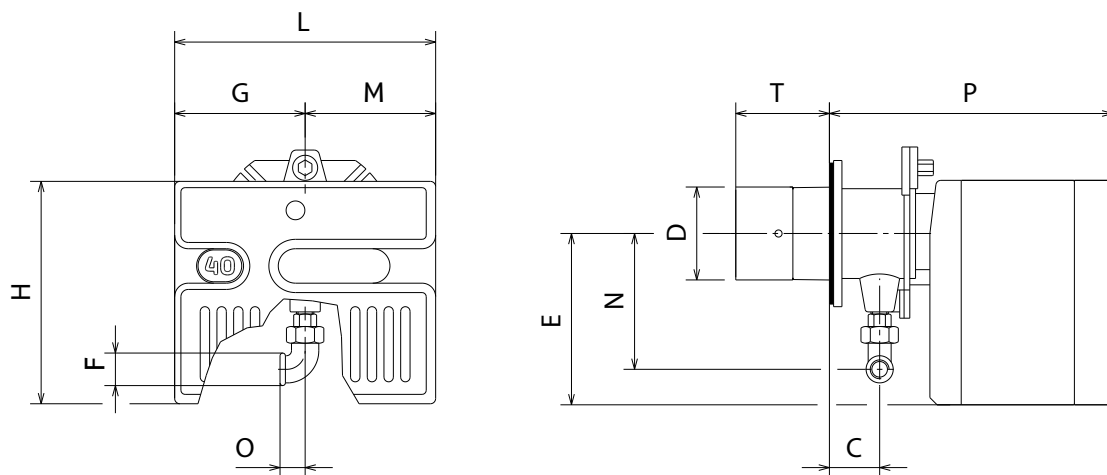

GS10 - GS20

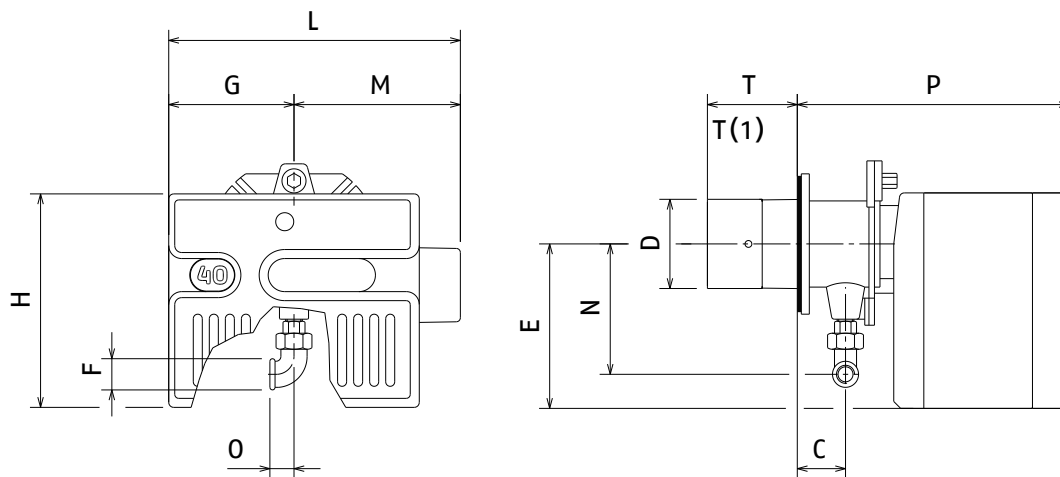

MODEL	L	G	M	H	P	T - T(1)	D	E	C	N	O
GS3	252	126	126	215	230	100	91	165	37	132	25
GS5	272	136	136	233	295	100	91	180	48	138	28
GS10	341	152.5	188.5	262	346	110	105	204	61	142	33
GS10***	305	152.5	152.5	262	346	110 - 170	105	204	61	142	33
GS20	387	175	212	298	389	120 - 280	125	230	67	152	33
GS20***	350	175	175	298	389	120	125	230	67	152	33

* With reduction nipple
 ** Standard equipment on R40 GS3
 *** Versions with air damper opening motor inside the cover
 (1) Dimension with extended head

BURNER - BOILER MOUNTING FLANGE

GS3 - GS5

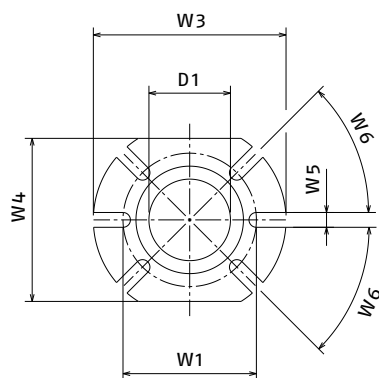

GS10 - GS20

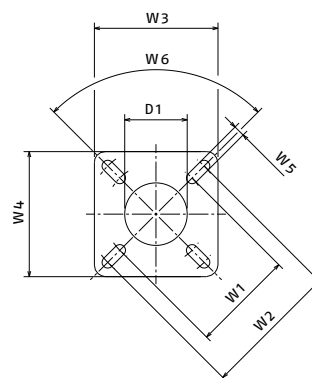

MODEL	D1	W1	W2	W3	W4	W5	W6
GS3	104	130	-	170	140	10	45°
GS5	104	130	-	170	140	10	45°
GS10	114	130	-	185	160	11	45°
GS20	125	155	200	170	170	11	45°

PACKAGING

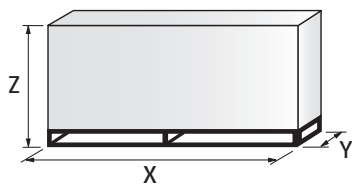

MODEL	X	Y	Z	kg
GS3	375	335	310	11
GS5	445	355	325	11
GS10	483	423	330	15
GS20	535	463	375	21

Installation Description

Installation, start up and maintenance must be carried out by qualified and skilled personnel. The burner is set in factory on standard calibration (minimum output), if necessary adjustments can be made on the basis of the maximum output of the boiler. All operations must be performed as described in the technical handbook supplied with the burner.

BURNER SETTING

The air damper position can be easily adjusted removing the burner cover.

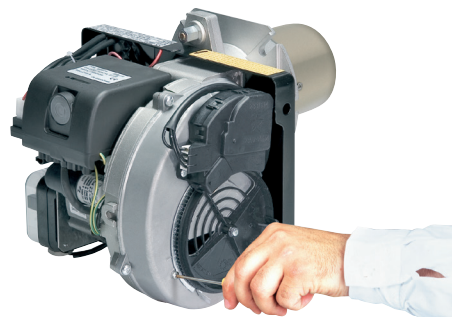

Head setting is easy and aided by a graduated scale, a test point allows reading the air pressure in the combustion head.

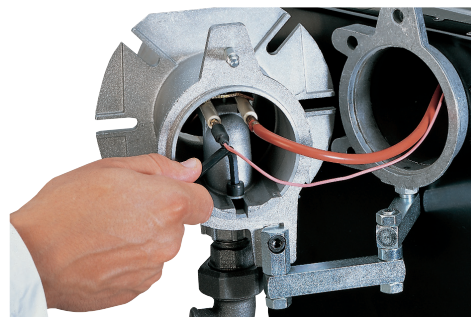

Riello 40 GS burners are fitted with an air pressure switch which, in accordance with EN 676 standards, can be adjusted by the installer using a graduated selector, on the basis of the effective working conditions.

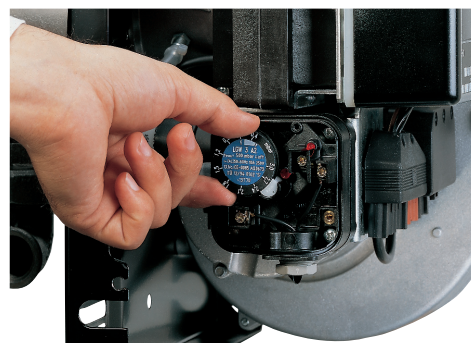

MAINTENANCE

Maintenance is easily solved because the combustion head can be disassembled without having to remove the burner from the boiler.

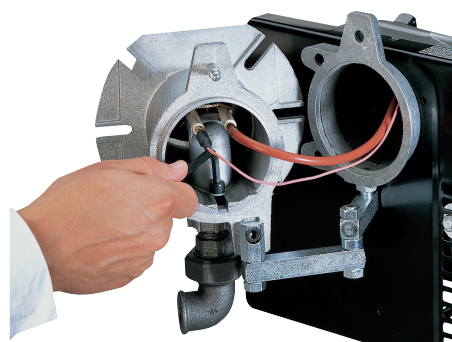

Burner accessories

EXTENDED HEAD KIT

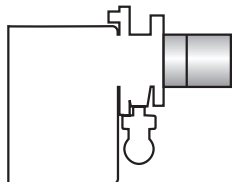

“Standard head” burners can be transformed into “extended head” versions by using the special kit. Below the KITS available for the various burners are listed, showing the original and the extended lengths.

BURNER	STANDARD HEAD LENGTH (mm)	EXTENDED HEAD LENGTH (mm)	CODE
GS3 - GS5	100	125	3000820
GS10	110	170	3001064
GS20	120	280	3000873

REMOTE RESET CONTROL KIT FOR THE MG 557 CONTROL BOX

The MG 557 control box can be remotely released using an electric command kit. This kit must be installed in conformity with the local authority.

BURNER	CODE
GS3 - GS5	3002750

LPG KIT

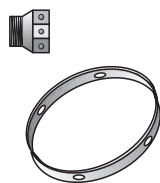

For burning LPG gas, a special kit is available to be fitted to the combustion head on the burner, as shown in the following table.

BURNER	STANDARD HEAD CODE	EXTENDED HEAD CODE
GS3	3000881	3000881
GS5	3000882	3000882
GS10	3000884	3000884
GS20	3000886	3000886

TOWN GAS KIT

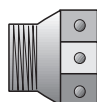

BURNER	CODE
GS3	3000888
GS5	3000889
GS10	3000891
GS20	3000893

GROUND FAULT INTERRUPTER KIT



A “Ground fault interrupter kit” is available as a safety device in case of electrical system fault. It is supplied with burners with pin plug.

BURNER	CODE
GS3 - GS5 - GS10 - GS20	3001180

7-PIN PLUG KIT

If necessary a 7-pin plug kit is available (in packaging of n. 5 pieces).

BURNER	CODE
GS3 - GS5 - GS10 - GS20	3000945

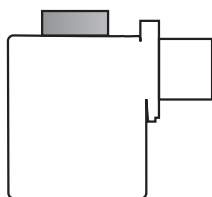
INLET AIR ASPIRATION KIT

This kit allows to channel the external air directly into the burner and is available as accessory for models.

BURNER	CODE
GS3	20027571
GS5	20027576
GS10	20027578
GS20	20027581

END CONE WITH TURBULATOR DISK

The end cone turbulator disk reduces the flame length. It is suitable for hoven application (CO emissions) and short boiler chamber.

BURNER	PROJECTION (mm)	CODE
GS5	+15	3000916
GS10	+18	3000918
GS20	+23	3000919

CONTINUOUS VENTILATION KIT FOR RMG CONTROL BOX

If the burner requires continuous ventilation in the stages without flame, a special kit is available as given in the following table.

BURNER	CODE
GS10 - GS20	3010094

PC INTERFACE KIT

To connect the control box to a personal computer for the transmission of operation, fault signals and detailed service information, an interface adapter with PC software are available.

BURNER	CODE
GS10 - GS20	3002719

Gas train accessories

SEAL CONTROL KIT



To test the valve seals on the gas train, (except for the model with Multibloc MBC 65 DLE) a special "seal control kit" is available.

GAS TRAIN	CODE	
	for 50Hz operation	for 60Hz operation
MB/1 type	3010123	20050030

Specification

DESIGNATION OF SERIES

A specific index guides your choice of burner from the various models available in the GS series. Below is a clear and detailed specification description of the product.

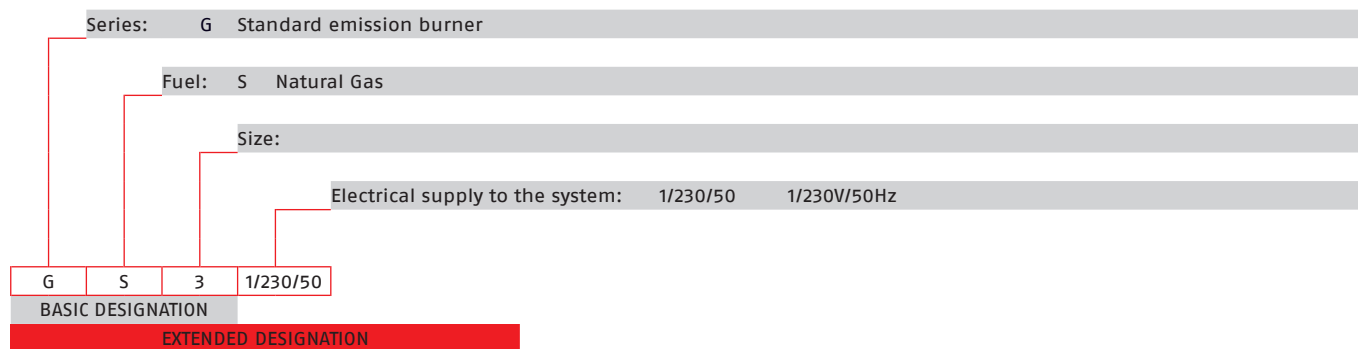

AVAILABLE BURNER MODELS

BURNER MODELS	ELECTRICAL SUPPLY	HEAT OUTPUT		TOTAL ELECTRICAL POWER (kW)	CERTIFICATION	NOTE
		(kW)	NATURAL GAS (Nm ³ /h)			
GS3	1/230/50	11 - 35	1,1 - 3,5	0,100	CE-0476CT2714	(1) (5)
GS5	1/230/50	18 - 58	1,8 - 5,8	0,110	CE-0476CT2714	(1) (5)
GS5	1/220/60	23 - 65	2,3 - 6,5	0,180	-	(2) (4) (5)
GS10	1/230/50	42 - 116	4,2 - 11,6	0,130	CE-0476CT2714	(1)
GS10	1/220/60	42 - 116	4,2 - 11,6	0,200	-	(2) (4)
GS10	1/220/60	42 - 116	4,2 - 11,6	0,200	-	(1) (4) (5)
GS20	1/230/50	81 - 220	8,1 - 22	0,250	CE-0476CT2714	(1)
GS20 TL	1/230/50	81 - 220	8,1 - 22	0,250	CE-0476CT2714	(1)
GS20	1/220/60	81 - 220	8,1 - 22	0,430	-	(2) (4) (5)

Net calorific value G20: 10 kWh/Nm³ - Density: 0,71 kg/Nm³

The burners of GS series are in according to EN 676

(1) With plug and socket

(2) With terminal block

(3) Belgium version

(4) Korea version

(5) With air damper opening motor inside the cover

SPECIFICATION

STATE OF SUPPLY

Burner

Monoblock, gas burners, completely automatic, with one stage settings fitted with:

- Fan with forward curve blades
- Cover lined with sound-proofing material
- Air damper, completely closed in stand by, with adjustment inside the cover
- Single phase electric motor 230 V, 50 Hz
- Combustion head fitted with:
 - stainless steel head cone, resistant to high temperatures
 - ignition electrodes
 - ionisation probe
 - gas distributor
 - flame stability disk
- Adjustable air pressure switch, with graduated selector, to guarantee burner lock out in the case of insufficient combustible air
- Microprocessor-based burner safety control box (with diagnostic, remote reset, continuous purge integrated, recycle, post-purge)
- IP X0D (IP 40) electric protection level

Standard equipment:

- Flange insulation screen
- Screws and nuts for fixing the flange to the boiler
- 7-pole socket
- Hinge
- Reduction nipple Rp 1/2" - Rp 3/8" (for R40 GS3 only)
- Grommet
- Instruction handbook for installation, use and maintenance
- Spare parts catalogue

Conforming to:

- 2014/30 EU Directive (electromagnetic compatibility)
- 2014/35 EU Directive (low voltage)
- 2016/426 EU Gas Appliances Regulation
- 2006/42 CE Directive (machine)
- EN 676 (gas burners)

Available accessories to be ordered separately:

- Extended head kit
- Remote reset control kit for MG 557 control box
- LPG kit
- Town gas kit
- Ground fault interrupter kit
- 7-pin plug kit
- Inlet air aspiration kit
- End cone with turbulator disk
- Continuous ventilation kit for control box
- PC interface kit

Riello Burners a world of experience in every burner we sell.

01/2019
T50025UK05



[1]

Across the world, Riello sets the standard in reliable and high efficiency burner technology.

With burner capacity from 5 kW to 48 MW, Riello gas, oil, dual fuel and Low Nox burners deliver unbeatable performance across the full range of residential and commercial heating applications, as well as in industrial processes.

With headquarter in Legnago, Italy, Riello has been manufacturing premium quality burners for over 90 year. The manufacturing plant is equipped with the most innovative systems of assembling lines and modern manufacturing cells for a quick and flexible response to the market.

Besides, the Riello Combustion Research Centre, located in Angiari, Italy, represents one of the most modern facility in Europe and one of the most advanced in the world for the development of the combustion technology.

Today, the company's presence on worldwide markets is distinguished by a well-constructed and efficient sales network, alongside many important Training Centres located in various countries to meet its customers' needs. Riello has 13 operational branches abroad (in Europe, America and Asia), with customers in over 60 countries.



[2]

[1] BURNERS PRODUCTION PLANT
S. PIETRO, LEGNAGO (VERONA) - ITALIA

[2] HEADQUARTER BURNERS DIVISION
S. PIETRO, LEGNAGO (VERONA) - ITALIA

RIELLO S.p.A. - 37045 Legnago (VR) - Italy
tel. +39 0442 630111 - fax: +39 0442 21980
www.riello.com

Since the Company is constantly engaged in the production improvement, the aesthetic and dimensional features, the technical data, the equipment and the accessories can be changed. This document contains confidential and proprietary information of RIELLO S.p.A. Unless authorised, this information shall not be divulged, nor duplicated in whole or in part.

RIELLO