

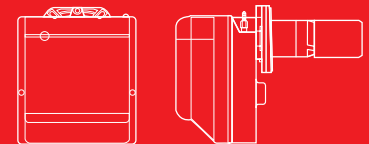

Gulliver BGK Series

Low NO_x One Stage Light Oil Burners

BGK0.1	22.5 ÷	35.3 kW
BGK1	17.8 ÷	35.6 kW
BGK2	32.0 ÷	59.3 kW
BGK3	45.0 ÷	73.0 kW



The Riello Gulliver BGK series of one stage light oil burners is a complete range of Low NOx products developed to respond to any request for home heating, conforming to the strictest standards regarding the reduction of polluting emissions.

The BGK series is available in four models with an output ranging from 17.8 to 73 kW, divided in two different structures.

All the models use the same components designed by Riello for the Gulliver series.

The high quality level guarantees safe working. The Gulliver BGK burners are fitted with a microprocessor-based control box, with diagnostic functions.

In developing these burners, special attention was paid to reducing noise, to ease of installation and adjustment, to obtaining the smallest size possible to fit into any sort of boiler available on the market.

All the models are approved by the European EN 267 Standard and conform to European Directives for EMC, Low Voltage and Machinery.

All the Gulliver BGK series of burners are fired before leaving the factory.

Technical Data

MODEL		BGK0.1	BGK1	BGK2	BGK3	
Burner operation mode		One stage				
Modulation ratio at max. output		-				
Servomotor	type	-				
	run time s	-				
Heat output	kW	22.5 ÷ 35.3	17.8 ÷ 35.6	32 ÷ 59.3	45.0 ÷ 73.0	
	Mcal/h	19.4 ÷ 30.4	15.3 ÷ 30.6	27.5 ÷ 51	38.7 ÷ 62.8	
	Kg/h	1.90 ÷ 2.95	1.5 ÷ 3.0	2.7 ÷ 5.0	3.8 ÷ 6.15	
Working temperature	°C min./max.	0/40				
FUEL/AIR DATA						
Light oil	net calorific value	kWh/kg	11.8			
		kcal/kg	10200			
	viscosity at 20°C	mm ² /s (cSt)	4 ÷ 6			
Pump	type	R.B.L				
	delivery at 12 bar	Kg/h	30			
Atomised pressure	bar	8 - 15				
Fuel temperature	max. °C	50				
Fuel pre-heater		YES				
Fan	type	Centrifugal with forward curve blades				
Air temperature	max. °C	40				
ELECTRICAL DATA						
Electrical supply	Ph/Hz/V	1/50/230 ± 10%				
Auxiliary electrical supply	Ph/Hz/V	-				
Control box	type	RBL 553 SE		M0 550		
Total electrical power	kW	0.22	0.25	0.27	0.46	
Auxiliary electrical power	kW	-				
Heaters electrical power	kW	-				
Protection level	IP	X0D (IP 40)				
Fan motor	electrical power	kW	0.09			
	rated current	A	0.9			
	start up current	A	3.6			
	protection level	IP	20			
Pump motor	electrical power	kW	-			
	rated current	A	-			
	start up current	A	-			
	protection level	IP	-			
Ignition transformer	type	Incorporated in the control box				
	V1 - V2	(-) - 8 Kv				
	I1 - I2	(-) - 16 mA				
Operation		Intermittent (at least one stop every 24h)				
EMISSIONS						
Noise levels	Sound pressure	dB (A)	61	62	63	62
	Sound power	W	72	73	74	73
Light oil	CO emission	mg/kWh	28	17.5	1.5	15
	grade of smoke indicator	N° Bacharach	< 1			
	CxHy emission	mg/kWh	< 10 (after the first 20s)			
	NOx emission	mg/kWh	89	108	105	110
APPROVAL						
Directive		2006/42/EC - 2014/30/UE - 2014/35/UE				
Conforming to		EN 267				

Reference conditions:

Temperature: 20°C - Pressure: 1013,5 mbar - Altitude: 0 m a.s.l. - Noise measured at a distance of 1 meter.

Since the Company is constantly engaged in the production improvement, the aesthetic and dimensional features, the technical data, the equipment and the accessories can be changed. This document contains confidential and proprietary information of RIELLO S.p.A. Unless authorised, this information shall not be divulged, nor duplicated in whole or in part.

Firing Rates

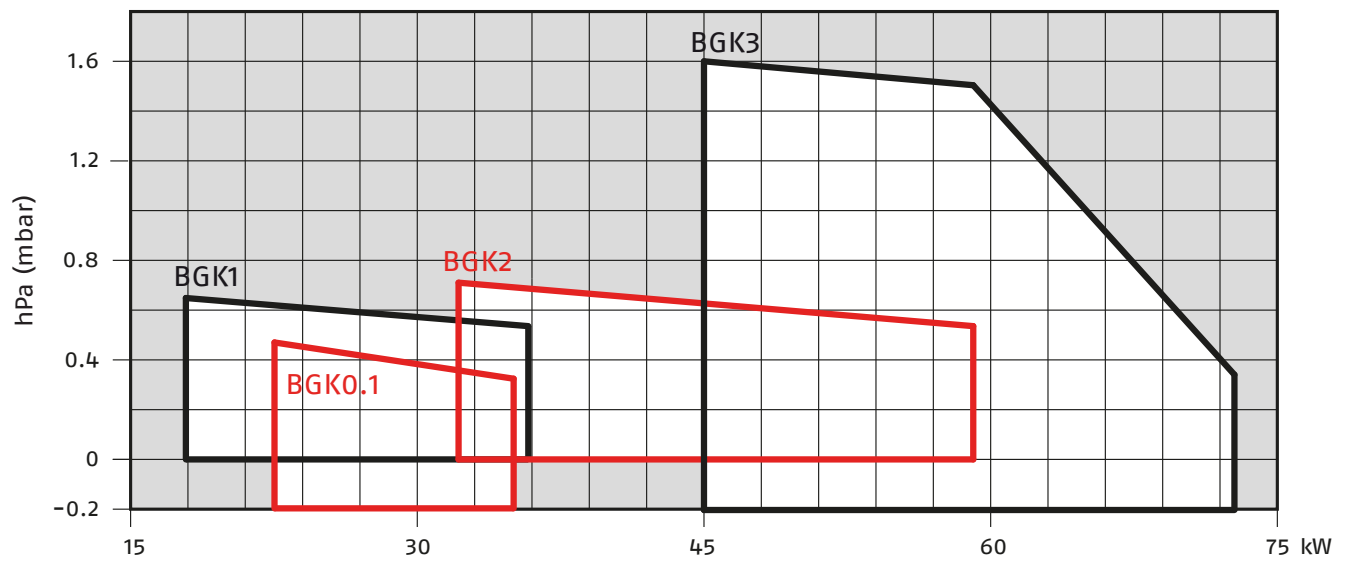

Useful working field for choosing the burner

Test conditions conforming to EN 267:
 Temperature: 20°C
 Pressure: 1013,5 mbar
 Altitude: 0 m a.s.l.

Fuel Supply

HYDRAULIC CIRCUIT

All the burners are fitted with a Riello geared pump, with safety valve on the return circuit, and a PTC light oil pre-heater.

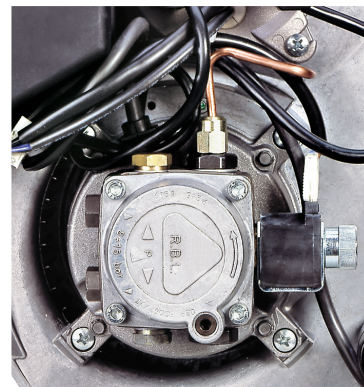

Fuel pump

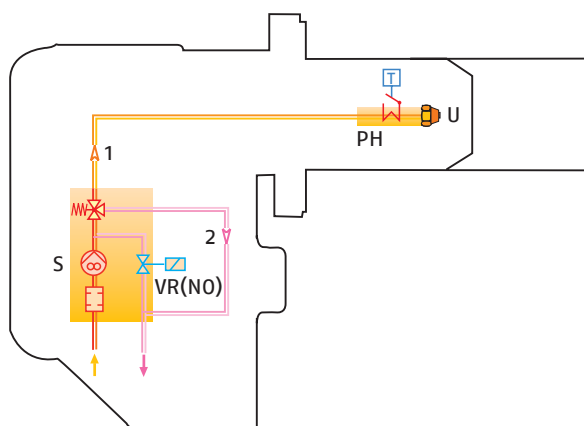

S	Pump with filter and pressure regulator on the delivery pipe
VR (NO)	Oil return valve normally open
1	Oil input pipe to the nozzle
2	Oil return pipe from the regulator
PH	Oil pre-heater with thermostat (where provided)
U	Nozzle (where provided)

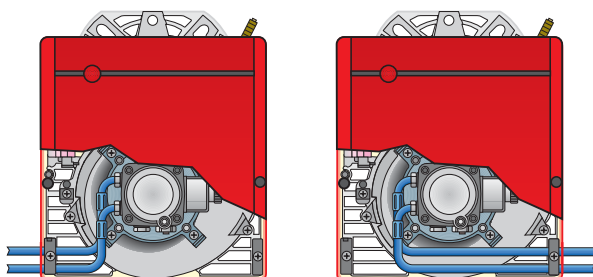

Fuel feed to the burner can be from the right or the left side on all models.

SELECTING THE FUEL SUPPLY LINES

The fuel feed must be completed with the safety devices required by the local regulations in force. The table shows the choice of piping diameter for the various burners, depending on the difference in the height between the burner and the tank and the distance between them.

Maximum equivalent length of the pipework L (m)				
	Type A system		Type B system	
Pipe size	∅ 8 mm	∅ 10 mm	∅ 8 mm	∅ 10 mm
H (m)	L _{max} (m)	L _{max} (m)	L _{max} (m)	L _{max} (m)
0	35	100	-	-
0.5	30	100	10	20
1.0	25	100	20	40
1.5	20	90	40	80
2.0	15	70	60	100
3.0	8	30	-	-
3.5	6	20	-	-

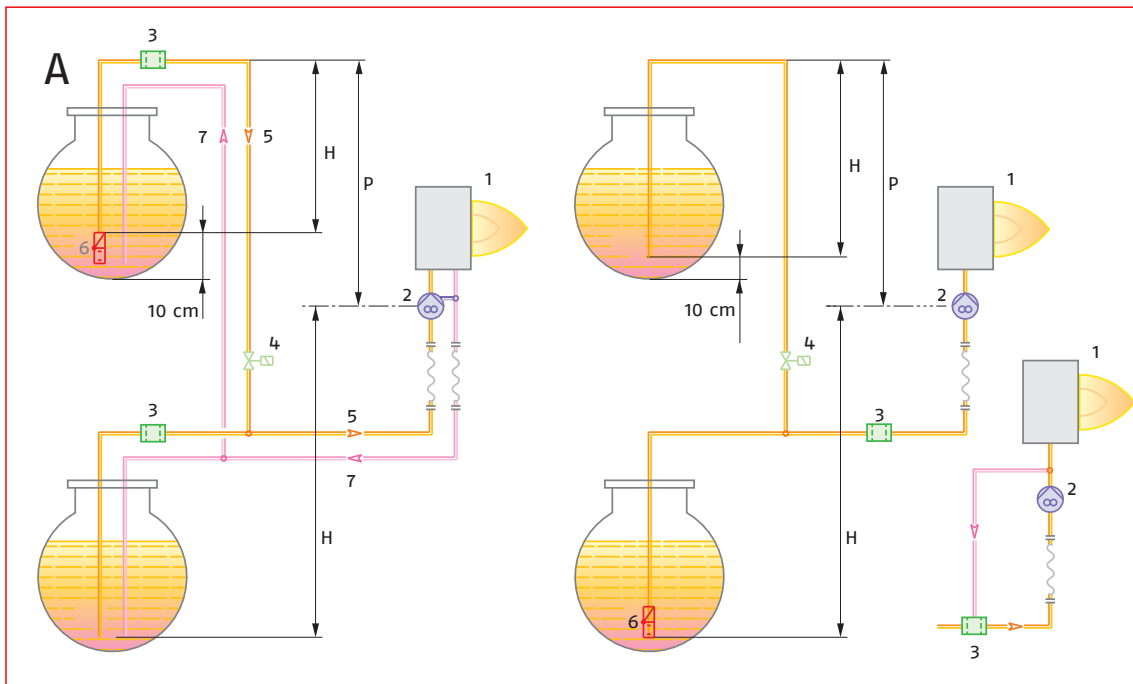

Type of system that can be installed

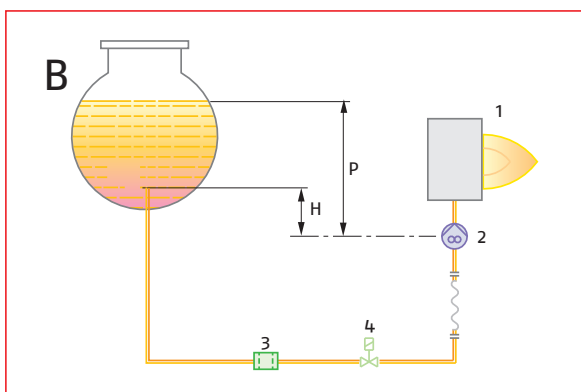

H	Difference in height
∅	Internal pipe diameter
P	Difference in height ≤ 4 m
1	Burner
2	Pump
3	Filter
4	Shut-off solenoid valve
5	Suction pipework
6	Bottom valve
7	Return pipework

Ventilation

The ventilation circuits always ensure low noise levels with high performance of pressure and air delivery, inspite of their compact size.



Air suction

Combustion Head

REDUCING FLAME TEMPERATURE

The configuration of the combustion head provokes internal recirculation of the combustion substances. This re-circulation reduces the flame temperature and therefore the NOx emissions. Furthermore, re-circulation of the combustion substances speeds up evaporation of combustible droplets creating gassy type combustion, similar to gas burner blue flame.

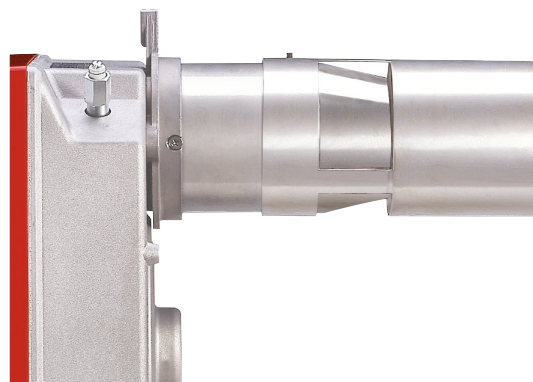
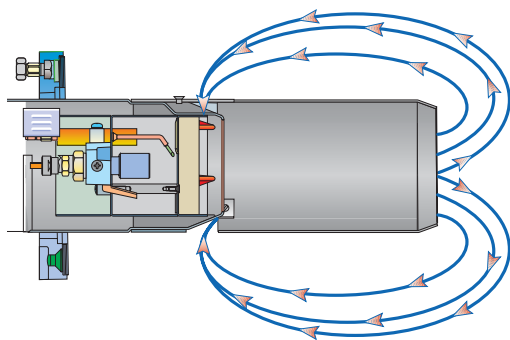

Combustion head

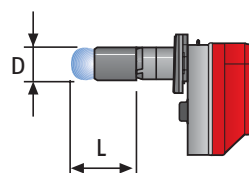
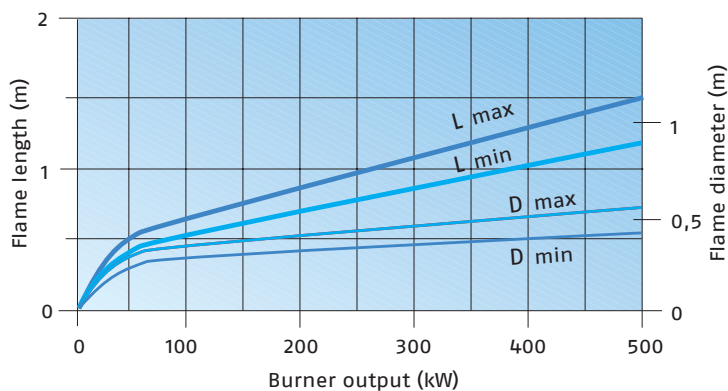

Example:
 Burner thermal output = 350 kW;
 L_{flame} (m) = 1.2 m (medium value);
 D_{flame} (m) = 0.6 m (medium value)

Operation

BURNER OPERATION MODE

All these models are one stage operation.

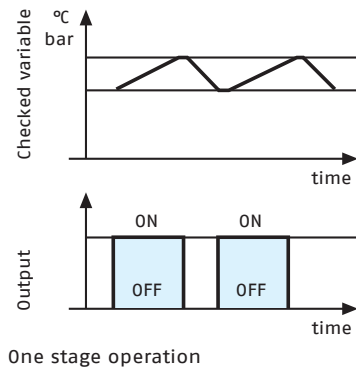

One stage operation



Air damper adjustment

The BGK 0.1 Gulliver model is fitted with the Riello model 553 SE control box and a simple photocell is used for flame detection; on request the M0 550 control box can be supplied.

The BGK1, BGK2 and BGK3 Gulliver models are fitted with the new microprocessor based Riello M0 550 control box for the supervision during intermittent operation.

This control box has the following features:

- Digital technology
- Visual or PC interface diagnostic functions through multi-color LED device
- Post-ignition of 3 seconds after safety time
- Adjustable post-purge
- Remote lock-out reset
- Post-combustion lock-out
- Recycling for 3 attempts if there is failure flame during operation
- Integrated ignition transformer with a 8 seconds ignition time (equal to control box safety time)
- Integrated 7-pole socket.

For helping the commissioning and maintenance work, there are two main elements:



The lock-out reset button is the central **operating element** for resetting the burner control and for activating / deactivating the diagnostic functions.



The multi-color LED is the central **indication element** for visual diagnosis and interface diagnosis.

Both elements are located under the transparent cover of lock-out reset button, as showed below.

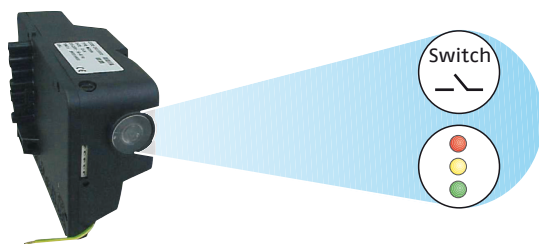

There are two diagnostic choices, for indication of operation and diagnosis of fault cause:

- visual diagnosis:

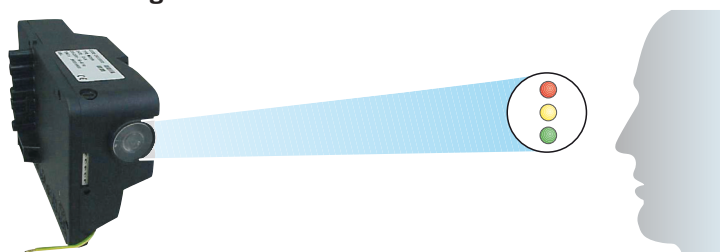

- interface diagnosis:

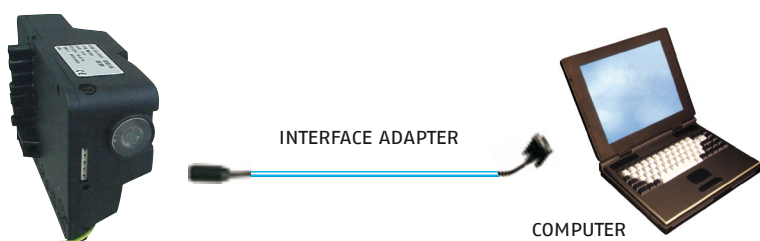

By the interface adapter and a PC with dedicated software.

Indication of operation:

In normal operation, the various status are indicated in the form of colour codes according to the table below.

Color code table

Operation status	Color code	Flash type
Stand-by	○ Led off	
Pre-heating	● Yellow continue	
Pre-purging	● Green continue	
Ignition	● ☀ Green continue + Yellow flashing	Fast
Flame OK	● ☀ Green continue + Yellow flashing	Slow
Post purge	● ☀ Green continue + Yellow continue	
Re-cycle	● ☀ Green continue + Yellow flashing	Medium
Lock out	● Red continue	Fast
Flame during pre-heating or stand-by	☀ Yellow flashing	Fast
Flame during post-purge	● ☀ Green continue + Yellow flashing	Fast
Flame during lock out	● ☀ Red continue + Yellow flashing	

Diagnosis of fault causes:

After lock-out has occurred, the red signal lamp is steady on. In this status, the visual fault diagnosis according to the error code table can be activated by pressing the lock-out reset button for > 3 seconds.



The control box sends a sequence of pulses that are repeated at 2-second intervals.

The interface diagnosis (with adapter) can be activated by pressing again the lock-out button for > 3 seconds.

Example of flashes sequence:

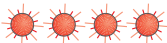

Error code table

Flash code	Possible cause of fault
2 flashes 	No flame at the end of safety time : - faulty or soiled fuel valves - faulty or soiled flame detector - poor adjustment of burner, no fuel - faulty ignition
4 flashes 	Extraneous light or presence of flame : - in stand-by position - with thermostat of heat demand in idle or working position - during oil-preheater - during pre-purge - during post-purge
7 flashes 	Flame failure during running position after n° 3 attempts of re-cycle : - faulty or soiled fuel valves - faulty or soiled flame detector - soiled ignition electrodes - poor adjustment of burner, no fuel
8 flashes 	Monitoring of oil-preheater : - faulty heater or oil-thermostat

The MO 550 digital control box gives some other advantages:

Post ignition

The spark ignition is present during all safety time and for supplementary time of 3 seconds.

Adjustable post purge

The Post-purge is a function that maintains air ventilation even after the burner is switched off.

Post-purge time can be set to a maximum of 6 minutes.

This function can be activated and set in a very easy way by pressing repeatedly the reset button; after 5 seconds the control box automatically shows the minutes set by the red LED flashing (1 pulse = post-ventilation for 1 minute).

If during post-purge there is a new request for heat, it is halted and a new operating cycle starts.

The control box leaves the factory with the setting 0 minutes (no post-ventilation).

Remote lock-out reset

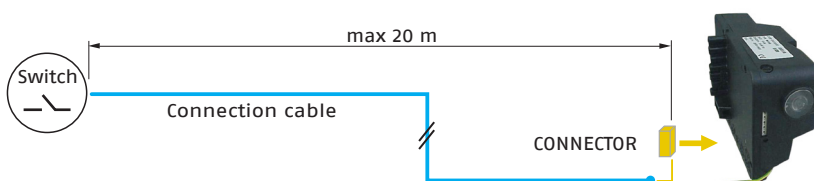

The 'Remote lock-out reset' is a function that allows to reset the control-box operation from a remote position. In the burner packages will be included a particular connector to remote the reset signal. The maximum length of connection must be 20 m.

START UP CYCLE

Control box RBL 553 SE

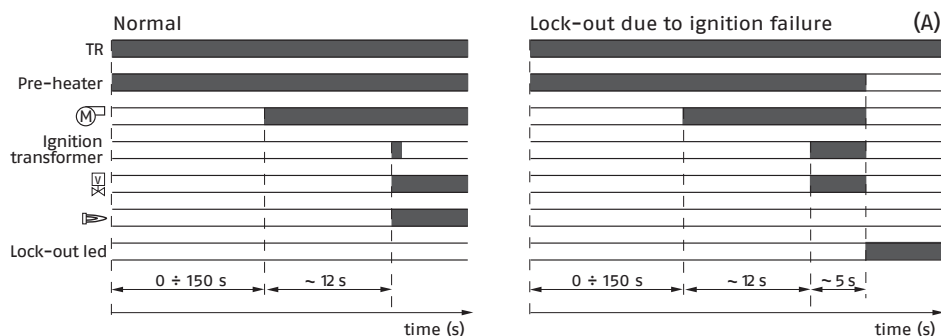

(A) Lock-out is shown by a led on the appliance.

Correct operation

- 0s The burner begins the ignition cycle
- 0s-150s Delay before pre-purge: this delay period can reach 150s, depending on the room and fuel temperatures
- 150s-162s Pre-purge with air damper open
- 162s Firing

Lock-out due to ignition failure

If the flame does not light within the safety limit (~5s) the burner locks-out.

Control box MO 550

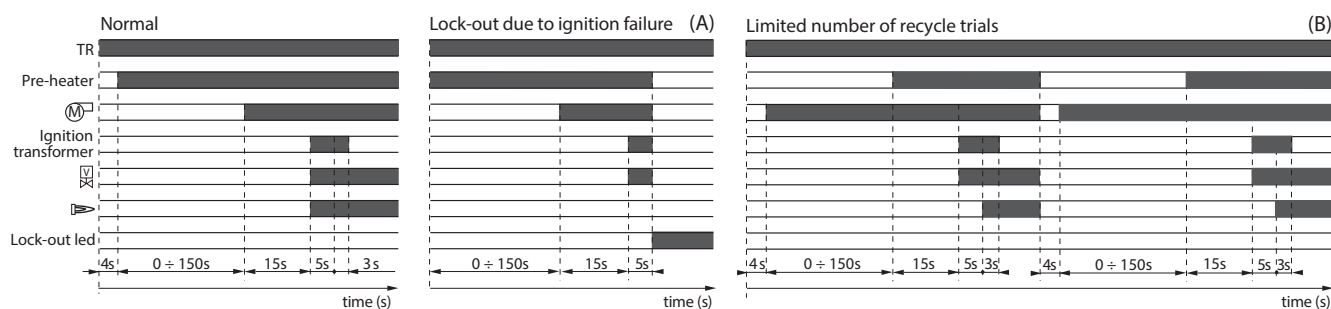

(A) Lock-out is shown by a led on the appliance.

(B) Total number of recycle trials is 3.

Correct operation

- 0s Start of heat demand the burner begins the ignition cycle
- 0s-4s The burner is in stand-by
- 4s-154s Delay before pre-purge: this delay period can reach 150s, depending on the room and fuel temperatures
- 154s-169s Pre-purge with air damper open
- 169s-174s Ignition transformer is on during all safety time
- 174s-177s Post-ignition: ignition transformer is on for supplementary time.

Lock-out due to ignition failure

If the flame does not light within the safety limit (~5s) the burner locks-out.

Re-cycle

The burner permits maximum three repetitions of complete ignition cycle if there is flame failure during operation. The burner goes in safety shut-down within one second. The final action at the last trial following at last flame failure is a lock-out.

Emissions

The emission data have been measured in the various models at maximum output, in conformity with EN 267 standard.

NO2 EMISSIONS

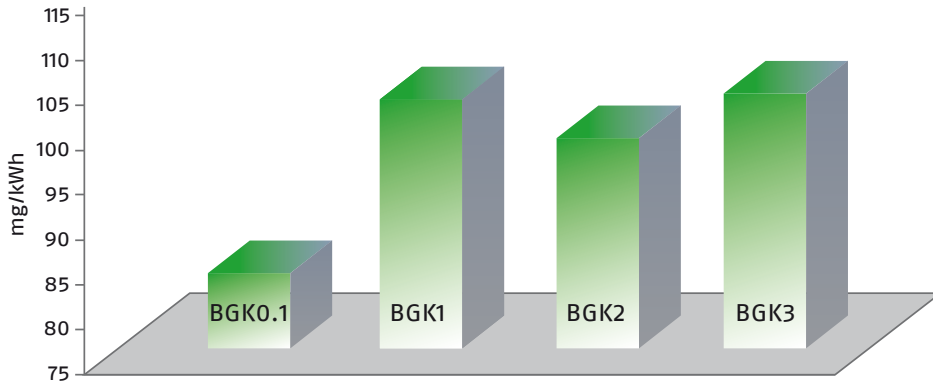

CO EMISSIONS

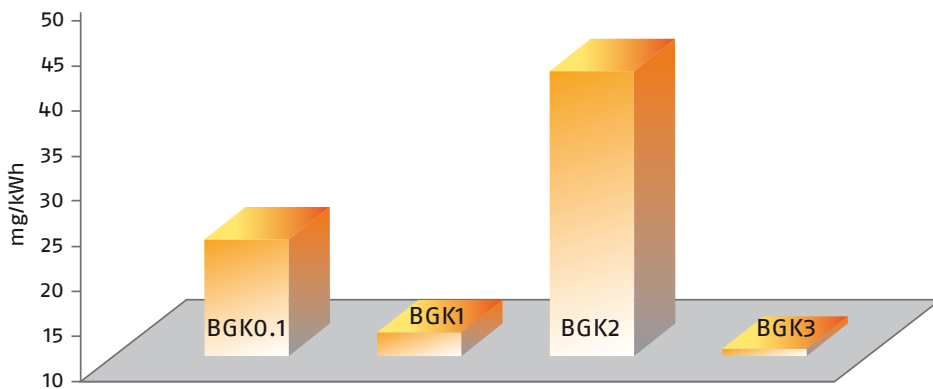

SOUND EMISSIONS (sound pressure)

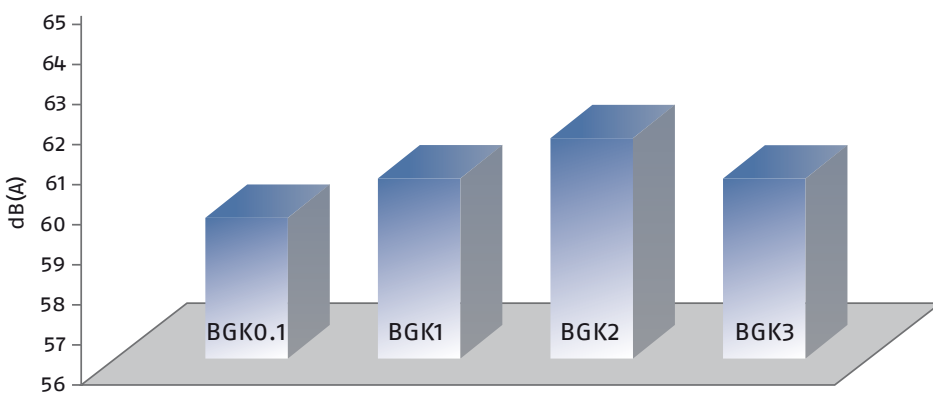

Special attention has been paid to noise reduction. All models are fitted with sound-proofing material inside the cover.

Overall Dimensions (mm)

These models are distinguished by their reduced size, in relation to their output, which means they can be fitted to any boiler on the market.

BURNER

BGK0.1

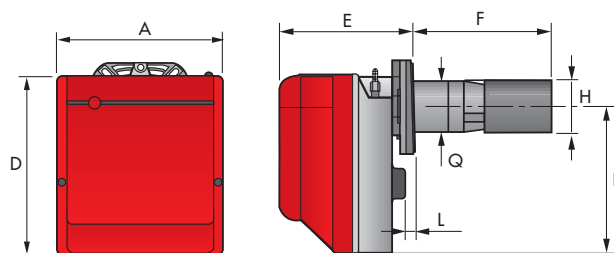

BGK1 - BGK2 - BGK3

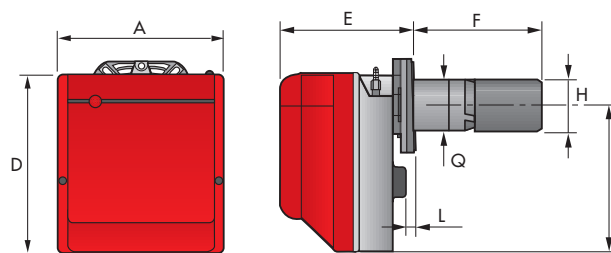

MODEL	A	D	E	F	H	I	L	Q
BGK0.1	234	254	196	191	87	210	4	84
BGK1	255	280	202	192	87	230	10	89
BGK2	255	280	202	197	90	230	10	89
BGK3	300	345	230	222	90	285	12	89

IMPORTANT: Boiler door must have a max. thickness of 70 mm for BGK0.1, 80 mm for BGK1 and 90 mm for BGK2 and BGK3, refractory lining included.

BURNER - BOILER MOUNTING FLANGE

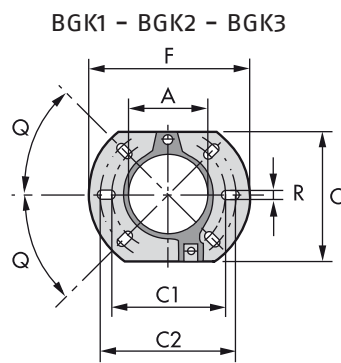
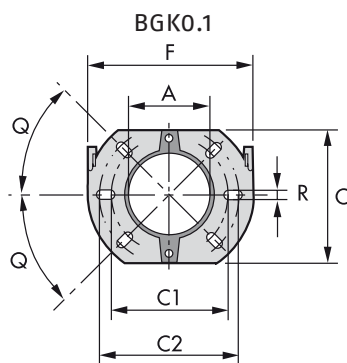

MODEL	A	C	C1	C2	F	Q	R
BGK0.1	91	144	130	150	180	45°	11
BGK1	106	166	140	168	189	45°	11
BGK2	106	166	140	168	189	45°	11
BGK3	106	166	140	168	189	45°	11

PACKAGING

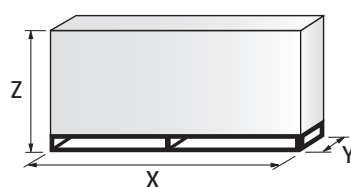

MODEL	X	Y	Z	kg
BGK0.1	343	268	310	13
BGK1	533	288	340	13
BGK2	533	288	340	13
BGK3	430	345	430	16.5

Installation Description

Skilled and qualified personnel must perform installation, start up and maintenance. A nozzle is fitted to the burner and used for fire tests in the factory. If necessary, change the nozzle on the basis of the maximum output of the boiler. All operations must be carried out as described in the technical handbook supplied with the burner.

BURNER SETTING

The air damper can be opened without removing the burner cover.

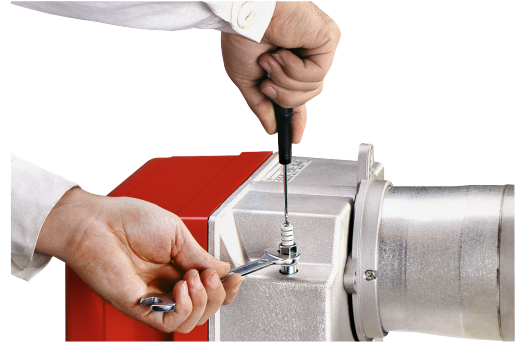

Head setting area is easily accessible and the operation is simple thanks to a graduated scale.

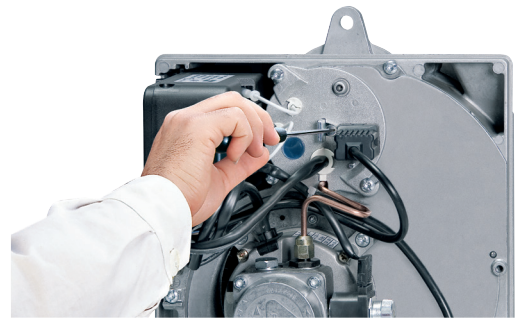

MAINTENANCE AND ELECTRICAL CONNECTIONS

The nozzle holder can be serviced through the rear cover without detaching the burner from the boiler.

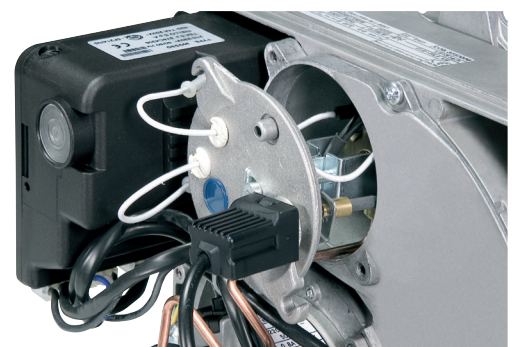

The 7-pole socket is incorporated in the control box. The 7-pin plug is also supplied for connection to the boiler.

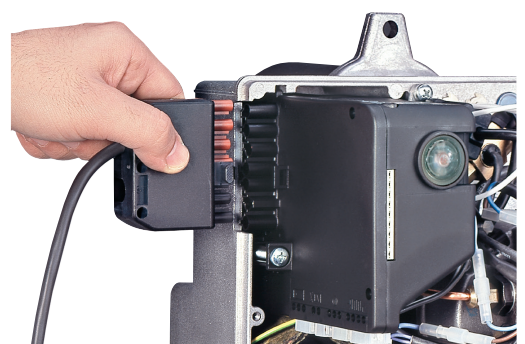

Burner accessories

CONTROL BOX M0 550 AND SENSOR FLAME



On request, we can supply a more efficient control box with following features:

- Digital technology
- Post-ignition of 3 seconds after safety time (total ignition time of 8 seconds)
- Multi-color LED signalling the various working stage
- Visual or PC interface diagnostic functions through multi-color LED device
- Remote lock-out reset (the connection is supplied with the M0 550 accessory)
- Recycling for 3 attempts if there is flame failure during operation
- Programmable post-purge (up to 6 minutes), continuous purge, long pre-purge (2 minutes)
- Post-combustion lock-out
- Logging of burner operation parameters (for example operating time, number and type of lock-outs)

BURNER	CODE
BGK0.1	3001168+3007492

PC INTERFACE KIT



To connect the control box to a personal computer for the transmission of operation, fault signals and detailed service information, an interface adapter with PC software are available.

BURNER	CODE
All models	3002731

LIGHT OIL FILTER



For cleaning light oil from dirty particles and impurities filters with the following features are available:

BURNER	FILTERING DEGREE (μm)	CODE
All models	60	3006561

Filter made up of aluminium body and stainless steel filtering cartridge; available singularly.

BURNER	FILTERING DEGREE (μm)	CODE
All models	60	3075011

Filter made up of aluminium cover, plastic tank and nylon filtering cartridge; available in packaging of 50 pieces.

LIGHT OIL FILTER/DEGASSING UNIT



To solve problems of air or water in the oil circuit a special filter/degassing unit is available, made up of aluminium cover, plastic tank, stainless steel filtering cartridge, air release cap and water purge valve. It is available singularly.

BURNER	FILTERING DEGREE (μm)	CODE
All models	100	3000926

7-PIN PLUG KIT

If necessary a 7-pin plug kit is available (in packaging of n. 5 pieces).

BURNER	CODE
All models	3000945

Specification

DESIGNATION OF SERIES

A specific index guides your choice of burner from the various models available in the BGK series. Below is a clear and detailed specification description of the product.

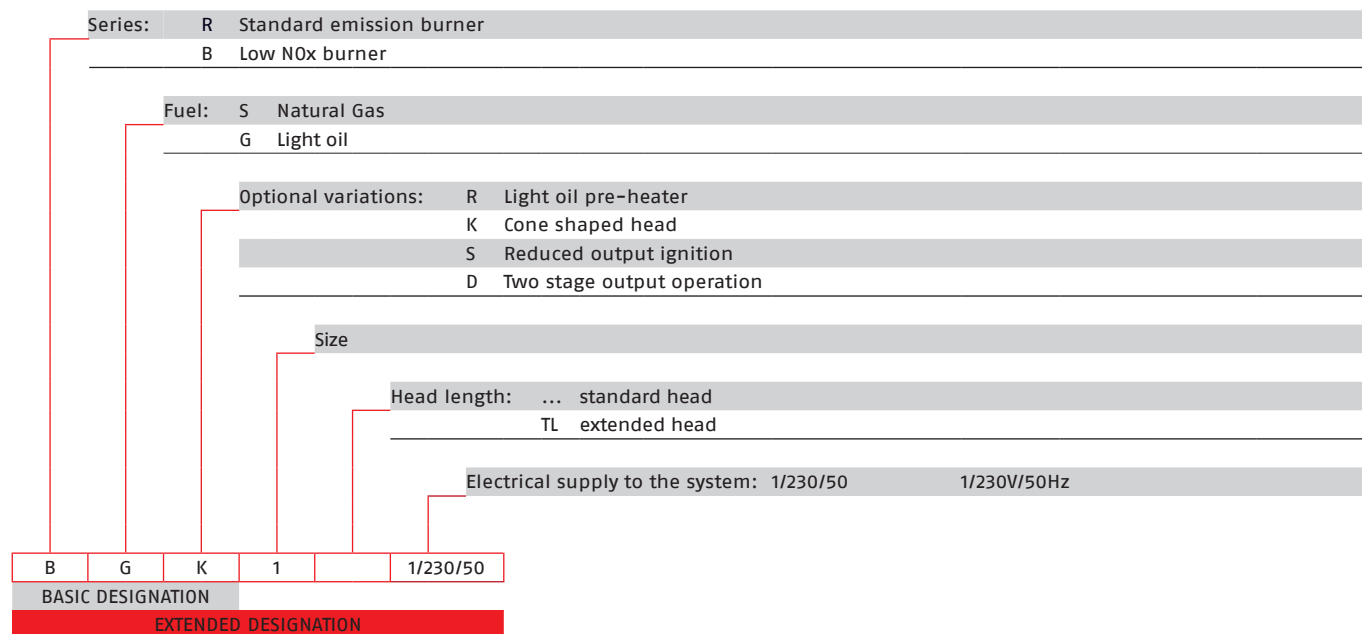

AVAILABLE BURNER MODELS

BURNER MODELS	ELECTRICAL SUPPLY	HEAT OUTPUT		TOTAL ELECTRICAL POWER (kW)	NOTE
		(kW)	(kg/h)		
BGK0.1	1/230/50	22.5 - 35.3	1.9 - 2.95	0.22	
BGK1	1/230/50	17.8 - 35.6	1.5 - 3	0.25	
BGK2	1/230/50	32 - 59.3	2.7 - 5	0.25	
BGK3	1/230/50	45 - 73	3.8 - 6.15	0.46	

Net calorific value: 11,8 kWh/kg; 10200 kcal/kg - Viscosity at 20°C: 4±6 mm²/s (cSt).
 The burners of BGK series are in according to EN 267.

SPECIFICATION

STATE OF SUPPLY

Burner

Completely automatic monobloc light oil burners, with one stage operation fitted with:

- Fan with forward inclined blades
- Sound deadening cover
- Air damper with external adjustment, with no need to remove the cover
- Single phase electric motor 230 V, 50 Hz
- Combustion head, fitted with:
 - stainless steel end cone resistant to high temperatures
 - ignition electrodes
 - flame stability disk
- Geared pump for fuel supply, fitted with:
 - filter
 - pressure regulator
 - connectors for installing a pressure gauge and vacuumeter
 - internal by-pass for preparing for single pipe installation
- Post-ignition of 3 seconds after safety time
- Fuel feed solenoid incorporated in the pump
- Photocell for flame detection with optical fibre
- Microprocessor-based burner safety control box M0 550, with diagnostic and remote control release functions (BGK1 – BGK2 – BGK3 models)
- Protection filter against radio interference (included into burner safety control box)
- Light oil nozzle
- IP X0D (IP 40) electric protection level
- PTC fuel heater.

Standard equipment

- Flange with insulating gasket
- Screws and nuts for flange
- Recirculating pipe
- Four screws and nuts for flange to be fixed to boiler
- Remote control release kit
- Two flexible oil pipes with nipples
- 7-pin plug kit
- Instruction handbook for installation, use and maintenance
- Spare parts catalogue.

Conforming to:

- 2014/30 UE Directive (electromagnetic compatibility)
- 2014/35 UE Directive (low voltage)
- 2006/42 EC Directive (machine)
- EN 267 (liquid fuel burners)

Available accessories to be ordered separately:

- Control box M0 550 and sensor flame
- PC interface kit
- Light oil filter
- Light oil filter/degassing unit
- 7-pin plug kit

Riello Burners a world of experience in every burner we sell.

06/2017
TS0010UK05



[1]

Across the world, Riello sets the standard in reliable and high efficiency burner technology.

With burner capacity from 5 kW to 48 MW, Riello gas, oil, dual fuel and Low Nox burners deliver unbeatable performance across the full range of residential and commercial heating applications, as well as in industrial processes.

With headquarter in Legnago, Italy, Riello has been manufacturing premium quality burners for over 90 year. The manufacturing plant is equipped with the most innovative systems of assembling lines and modern manufacturing cells for a quick and flexible response to the market.



[2]

Besides, the Riello Combustion Research Centre, located in Angiari, Italy, represents one of the most modern facility in Europe and one of the most advanced in the world for the development of the combustion technology.

Today, the company's presence on worldwide markets is distinguished by a well-constructed and efficient sales network, alongside many important Training Centres located in various countries to meet its customers' needs. Riello has 13 operational branches abroad (in Europe, America and Asia), with customers in over 60 countries.

[1] BURNERS PRODUCTION PLANT
S. PIETRO, LEGNAGO (VERONA) – ITALIA

[2] HEADQUARTER BURNERS DIVISION
S. PIETRO, LEGNAGO (VERONA) – ITALIA

RIELLO S.p.A. - 37045 Legnago (VR) - Italy
tel. +39 0442 630111 - fax: +39 0442 21980
www.riello.com

Since the Company is constantly engaged in the production improvement, the aesthetic and dimensional features, the technical data, the equipment and the accessories can be changed. This document contains confidential and proprietary information of RIELLO S.p.A. Unless authorised, this information shall not be divulged, nor duplicated in whole or in part.

RIELLO